

STANLEY[®]
Security Solutions



DOOR HARDWARE

K2 PRICE LIST VOLUME FOUR

Effective: April 4, 2011



STANLEY



Table Of Contents

A. General Information

Warranty Statement
About Us
Website
Packaging
Contact Info
Terms & Conditions

B. Forms

Purchase Order
Keying System Summary
Order Verification
Acknowledgement

C. Cylinders, Keys & Keying

Key System Security Policy
Keying Options
Keys & Cylinder Offering

D. Mortise Locksets - Grade 1

QMS100 - Sectional
QME100 - Escutcheon
QML100 - Deadlock

E. Cylindrical Locksets - Grade 1

QCL100 Series

F. Cylindrical Locksets - Grade 2

QCL200 Series

G. Interconnected Levers

QCI200 Series

H. Tubular Locksets

QTL200 Series

I. Auxiliary Deadbolts - Grade 1

QDB100 Series

J. Auxiliary Deadbolts - Grade 2

QDB200 Series

K. Exit Devices & Trims - Heavy Duty

QED100 Series
QET100 Series

L. Exit Devices & Trims - Standard Duty

QED300 Series
QET300 Series
QRT300 Series

M. Door Closers - Extra Heavy Duty

QDC100 Series

N. Door Closers - Heavy Duty

QDC200 Series

O. Door Closers - Standard Duty

QDC300 Series

P. Index

Weights & Measurements
Competitive Cross Reference



- **LIFETIME MECHANICAL WARRANTY**
- **3 YEAR FINISH WARRANTY**
- **1 YEAR ELECTRICAL WARRANTY**

Product Warranty Information

This product comes with a **lifetime mechanical warranty** and a **three year finish warranty** to the original user of the K2 Commercial Hardware product against defects in material and workmanship as long as the original user occupies/manages the premises upon which the product was originally installed. The warranty **DOES NOT COVER** scratches; abrasions; deterioration due to the use of paints, solvents and other chemicals; abuse; or misuse, and **DOS NOT COVER** US10B/613 "Oil Rubbed Bronze" finish as it is a "Living Finish" and a change in appearance is the natural characteristic of the finish. This warranty **DOES NOT COVER** defects caused by improper installation or field modification. This warranty **DOES NOT COVER** the cost incurred in removing and installing a replacement product. Upon return of a defective product to K2 Commercial Hardware, K2 may repair or replace the product or refund the purchase price. K2 is not liable for incidental or consequential damages. Some states do not allow the exclusion or limitation of incidental or consequential damages, so this may not apply to you. This warranty gives you specific legal rights and you may also have other rights that vary from state to state. If a mechanical or finish defect occurs, please call 866-590-2094 or return it to K2 Commercial Hardware at:

**19701 DaVinci
Lake Forest, CA 92610
www.K2commercialhardware.com
866-590-2094**





K2 Commercial Hardware by Stanley Black & Decker offers the finest in security, quality, styling and customer service to designers, architects and builders.

The K2 product line includes locksets, auxiliary deadbolts, exit devices and door closers to meet all your commercial hardware needs.

K2 has one goal in mind—to be known as the brand that is easy to do business with. K2's industry-leading frontline and support teams will make doing business easy in every respect – from products that make K2 the logical choice for architects, designers and builders, to a support system staffed by people who care.

Website

K2's best in class web site has been designed from the ground up with you in mind, and features unsurpassed ease-of-use, quick links to important information, and features like these to help make your job easier:

General Features:

- Full product line with supporting image library
- Competitive cross reference
- Electronic versions of all literature

Customer Specific Features:

- Password protected
- Access to customer and technical support



Visit now and experience K2 online. Just another way we're easy to do business with.
www.k2commercialhardware.com

Packaging

Packaging designed with the customer in mind.

- Compartmentalized packaging allows for quick and easy installation
- Improved productivity for the installer—installation completed more rapidly than the competition
- Increased quality control with all the parts being visible



Contact Info

19701 Da Vinci
 Lake Forest, CA 92610
 Tech Support: 1-866-590-2094
 Fax: 1-866-493-4737



All sales are made by K2 only upon the following terms, conditions and submission of a written purchase order. Any additional or different terms or conditions set forth in any purchase order or similar communication are hereby rejected and shall not be binding or effective unless expressly assented to in writing by an authorized representative of K2.

1. PRICES

A. All prices are subject to change without notice and are not guaranteed. All orders will be shipped at prices in effect at time of shipment.

B. Prices stated do not include any sales, use or excise tax or any other tax, duty or charge which is now in effect or may be hereafter imposed by any Federal, State or other authority. All such taxes, duties or other charges shall be paid by customer unless the customer shall provide to us an exemption certificate acceptable to the appropriate authorities.

2. FREIGHT

A. All goods are invoiced FOB shipping point and responsibility will not be accepted for damages or pilferage. These claims should be submitted with proper documents to the delivering carrier.

B. **K2's standard policy is to pay freight charges on all orders \$3,000 list price or above** (accessories/parts: 300 lbs.) to a single destination in the continental U.S., by carrier and route of our choice. Shipments less than these quantities will not be shipped on a prepaid basis. Please see weight & measurements in the index of this price book.

C. Product is shipped by the carrier of our choice. If higher freight charges are incurred from customers specifying a carrier of route or their choice the additional cost will be added to that customer's invoice.

3. TERMS

Terms are 2% prompt payment discount for payment within 25 days from date of invoice, net 30 days from date of invoice.

4. ORDERS AND ACKNOWLEDGMENTS

A. The Company reserves the right to refuse orders which may be submitted without pricing or attached quote and all required information. Exception is made if K2 has on file the customer's written approval allowing K2 to process orders and refrain from short paying invoices because of any pricing discrepancies.

B. Acknowledgments are copies of your orders and should be checked by you. If something does not agree with your understanding, we should be notified at once.

C. If our customer shall become overdue on its account or otherwise defaults in any payment to us or if its financial condition shall at any time seem to us otherwise inadequate to warrant further shipment on an open account basis, we shall have the right, without liability, to refuse to accept any or all orders, to cancel any and all orders, to delay shipments to the customer, or to require advance payment before accepting or shipping any orders. All orders and all shipments are subject to approval by our Credit Department.

D. ALL SALES ARE FINAL.

5. ORDER CHANGES

Any changes made to special order items that occur 3 days or more after the order entry date will carry a longer lead time and may be charged a handling fee. The customer will be given the option of having the entire order shipped at a later date or the changed items shipped freight collect with the same discount as the original order.

6. MINIMUM CHARGES

Due to the expense involved in the entering, handling and charging for orders of low value, no invoice will be priced for less than \$50.00 net plus shipping charges, except for accessory parts.



7. SHIPMENTS

A. Upon delivery of shipments to the carrier, title to, and the risk of loss or damage in transit for, such shipments passes to our customer.

B. Orders will be filled to the extent of our stock on hand and any balance forwarded as soon as possible.

C. Shipping schedules are estimates only which cannot be guaranteed because of the nature of our products and material, labor and manufacturing conditions beyond our reasonable control. Under no circumstances shall we be responsible for any inability or delay in meeting shipping schedules or for any loss or damage (whether direct or consequential) resulting there from.

D. All goods are packed in quantities which our experience has shown to be the most convenient and suitable.

8. CLAIMS

Claims on prices must be submitted within thirty days from date of invoice. Price claims must be submitted in writing to: K2 Commercial Hardware, 19701 DaVinci, Lake Forest, CA 92610. Attn: Credit department.

9. RETURNED GOODS

No products may be returned without our prior written authorization. If a product return is authorized, our representative will provide you with a Return Goods Authorization form (RGA) for the returnable products. The RGA form must accompany the shipment of the returned products to us. If products were defective or were shipped in error a credit at the invoice price will be issued or replacement products will be shipped only after a thorough inspection of the returned products has been made by our representative and such inspection confirms that the products were defective or shipped in error. Please return defective products in their original packaging. We have no obligation to agree to the return of non-defective products properly shipped. If, in our discretion, we agree to the return of non-defective, properly shipped products: (a) you will be issued a credit based on the price in effect when the products are returned or at the invoice price, whichever is lower, less the cost of return freight; (b) we may apply a 30% restocking charge; and (c) returned products must be in their original package (master carton).

10. CANCELLATIONS

Cancellations will not be accepted on goods that are not regular stock (special order), which are in the process of being manufactured, or ready for shipment.

11. MATERIAL AND FINISHES

A. Specifications, weights, dimensions and descriptions are actual or careful estimates but are not guaranteed and are subject to change without notice.

B. We reserve the right to furnish materially equivalent substitutes for materials which cannot be obtained in sufficient quantities due to existing shortages.

C. Although we apply the finest protective coatings available to the plated surface of our products, brass, bronze, and other antique finishes have their limitations, and in time the protective lacquer may deteriorate from exposure to weather, perspiration, extremes of climate, frequency of use or other factors. Tarnishing or excessive wear of these finishes is, therefore, not a defect, but a normal process which is unavoidable. Therefore, unless a specific product warranty includes an extended warranty, the finish will not be repaired or replaced under our warranty for tarnishing or wear of finishes.



12. LIMITED WARRANTY

We issue different warranties for different products so that the warranty will match the performance of each product. We grant to our customers the same warranty granted to the ultimate consumer. The specific details of the warranty relating to each of the products to which these terms and conditions apply will be found with the product and in our product catalogue. THIS WARRANTY IS IN LIEU OF ALL OTHER WARRANTIES, EXPRESS AND IMPLIED. OUR LIABILITY TO OUR CUSTOMER IS LIMITED TO THAT STATED IN EACH SUCH WARRANTY AND UNDER NO CIRCUMSTANCES WILL WE BE LIABLE TO OUR CUSTOMERS FOR INCIDENTAL OR CONSEQUENTIAL DAMAGES. Please see warranty statement in the index of this price book.

For more information concerning any specific warranty contact us at:

Customer Service
K2 Commercial Hardware
19701 DaVinci
Lake Forest, California 92610
(866) 590-2094

13. PATENT INDEMNITY

We agree to defend any suit or proceeding brought against our customer so far as based on a claim that our products, or any part thereof, made solely to our specifications and furnished to our customer constitute an infringement of any U.S. patent, if notified promptly in writing and given authority, information and assistance at our expense for the defense of same, and we shall pay all damages and costs awarded therein, against our customer, in case our products, or any part thereof is in such suit held to constitute infringement and their use is enjoined, we will, at our expense and discretion, either procure for our customer the right to continue using the products or replace same with non-infringing products, or modify them so they become non-infringing, or remove such products and refund the purchase price (less depreciation, prorated from the purchase date). The foregoing states our entire liability for patent infringement by our products or any part hereof.

14. DEFAULT

If our customer is in default under any order or contract with us or any of our affiliated divisions or companies, or if we at any time shall not be satisfied with our customer's financial conditions or responsibility, we shall have the right, without prejudice to any other legal remedy, of suspending deliveries until such default or condition is remedied.

15. ASSIGNMENT

Our customer shall not assign its orders nor any of its rights or obligations there under without our prior written consent.

16. APPLICABLE LAW

These Terms and Conditions of Sale and any subsequent sales agreements between K2 and customer shall be construed in accordance with the laws of the State of California.

17. WAIVER AND MODIFICATION

No waiver or modification of any of the terms and conditions contained herein shall be effective unless such waiver or modification is in writing and signed by an authorized representative at our offices in Lake Forest, California.

18. CERTIFICATION

We hereby certify that the goods covered by our invoice have been produced in compliance with the Fair Labor Standards Act of 1938, as amended.



March 23, 2010

Subject: **BAA and Stimulus Act Eligibility for K2 Products**

To All US Government Contractors:

Our K2 Door Closers, Exit Devices, Levers, and Deadbolts are "made-to-order" to meet the Buy American requirements for construction materials, under the American Recovery and Reinvestment Act of 2009 (Stimulus Act). These K2 products are eligible for use on construction projects funded by the Stimulus Act, as specified in the interim Federal Acquisition Regulations (FAR), effective on March 31, 2009.

In addition, for federally funded projects estimated at \$7.804 million or more, our K2 products made in Taiwan and South Korea (designated WTO Government Procurement Agreement countries) are eligible for equal consideration with US domestic products, under provisions specified in both the traditional Buy American Act (BAA) and the Stimulus Act.

If you have any further questions on this subject, please contact me directly at 949-672-4076.

Best regards,

A handwritten signature in black ink that reads "Alan Wander".

Alan Wander
Director- Customs Compliance
Stanley Black & Decker K2 Commercial Hardware

19701 Da Vinci
Lake Forest, CA 92610
Tech Support: 1-866-590-2094
Fax: 1-866-493-4737
www.k2commercialhardware.com



Keying System Summary

SHEET	DATE:	PURCHASE ORDER #:	SALES ORDER #:
1 of 2			

SOLD TO:

SHIP TO:

1. JOB NAME & ADDRESS

5. KEY QUANTITY

MASTER LEVEL	STAMP	QTY
<input type="checkbox"/> GGM
<input type="checkbox"/> GM
<input type="checkbox"/>
<input type="checkbox"/> MK/GROUP
<input type="checkbox"/>
<input type="checkbox"/> OTHER
<input type="checkbox"/> OTHER
<input type="checkbox"/> OTHER

2. SYSTEM STATUS

NEW EXISTING

3. SYSTEM TYPE

SKD Maison (Cross Keying)

MK CK (Construction Keying)

GMK

GGМК

CHANGE KEYS* **QTY**

PER CYLINDER/LOCKSET

PER KEYED ALIKE GROUP

*Two cut change keys are standard per lockset/cylinder.
Key blanks cannot be substituted for cut keys

4. KEYS

KEYWAY SELECTION

KWIKSET YALE - GA

WEISER SARGENT - LA

SCHLAGE - C SFIC - F (IC CORE)

KEY & CYL STAMPING

VKC0 No Bitting or Key Set Stamping on Keys CKC2 Concealed Key Control Cylinders & VKC Keys

VKC1 Visual Key Stamping (Keys Only) CKC3 Concealed Key Control Cylinders Only

VKC2 Special Stamping (other than standard symbols) DND Do Not Duplicate (Keys Stamped)

VKC3 Visual Key Control (Cylinder face only - levers & deadbolts) - Keys: up to 6 characters
- Cylinder face: Up to 4 characters

VKC4 Visual Key Control (Keys & Cylinder face) - Cylinder side: Up to 6 characters

6. CROSS KEYING

KEY SYMBOL	TO BE OPERATED BY (OBY)
.....
.....
.....
.....
.....
.....
.....
.....
.....
.....



SHEET	DATE:	PURCHASE ORDER #:	SALES ORDER #:
2 of 2			

SOLD TO:

.....

.....

.....

10. BITTING LIST

PROVIDE BITTING LIST FOR THIS ORDER:

YES NO

LETTER OF AUTHORIZATION:

ATTACHED

MAIL BITTING LIST TO:

.....

.....

ATTENTION:

7. PACKAGING & MARKINGS

PACK CHANGE KEYS WITH LOCKS/CYLINDERS (STANDARD)

PACK CHANGE KEYS SEPARATELY

LABEL ENVELOPES:

KEY SYMBOL DOOR NUMBER

JOB NAME OTHER*

*MARKINGS FOR OTHER:

.....

SHIP CHANGE KEYS TO:

.....

.....

ATTENTION:

8. SHIPPING INSTRUCTIONS FOR MASTER KEYS

SHIP MASTER KEYS TO:

.....

.....

ATTENTION:

9. SHIPPING INSTRUCTIONS FOR CONSTRUCTION KEYS

SHIP CONSTRUCTION KEYS TO:

.....

.....

ATTENTION:

11. CONTACT

NAME OF INDIVIDUAL IN YOUR ORGANIZATION WHO IS KNOWLEDGEABLE ABOUT THIS PROJECT, SHOULD ANY CLARIFICATION BE NECESSARY (Please Print):

NAME:

FAX #:

PHONE #:

THIS FORM HAS BEEN COMPLETED BY (Please Print):

NAME:

ADDITIONAL INFORMATION (ATTACH)

.....

.....

.....

.....

STANLEY



Acknowledgement

K2 / STANLEY BLACK & DECKER CORPORATION

19701 DA VINCI
LAKE FOREST, CA. 92610

Date:

Company:

Attention:

Total pages including this cover letter:

Customer Purchase Order#

K2/Order#

Enclosed is your acknowledgment for the above order.

We request your careful inspection of this acknowledgment. If it is not consistent with your purchase order, please advise us immediately with discrepancies. An order verification form is included on the next page for your convenience.

In order for us to meet our manufacturing 10 working day lead time, all orders must be confirmed within 24 hours of entry into our system.

A verification of approval or corrections are required within 24 hours of receiving this acknowledgement. A representative will contact you if this time period is exceeded. Late confirmations may result in an adjustment of your promise date.

Once verified and confirmed, we are unable to change or cancel your order. Should changes or cancellations be necessary, orders may be subject to a fee and adjustments made to your promise date. Adherence to this policy is required to meet our scheduled delivery projections.

We thank you for your cooperation and if you have any questions, please contact us at the phone or fax numbers listed below.

Best regards,

Pamela Hunt
K2 Commercial Supervisor
K2/Stanley Black & Decker

19701 Da Vinci
Lake Forest, Ca. 92610
Office Phone : (949) 672-4543
Toll Free: (866) 590-2094
Fax: (866) 493-4737

e-mail : pamela.hunt@bdhhi.com



Key System Security Policy

The purpose of this security policy is to protect the key system integrity of our customer's facilities by *strictly enforcing* the K2 Commercial Hardware policies concerning key system information.

- No master key system information or security-related product is to be given or sold to anyone other than the Facility Owner through written correspondence.
- Verification must be submitted (fax copy will be acceptable) to Key Systems Administration.
- The verification must be on the Facility's letterhead and signed by a Facility-authorized system administrator. The letter must state the name, address and contact person to whom the information may be released. (Authorized Dealer)
- Our Customer Service department does not maintain "Letters of Authorization" on file.
- Each order must be accompanied by proper authorization.
- Only after the authorization has been verified will an order be processed for production.

This security policy includes the following:

- Bitting information (even one bitting, absolutely no top level master keys)
- Bitting lists (all formats; i.e., hard copy, disc)
- Pre-built Cylinders extending a system
- Master Keys and Construction Keys (any level)

No orders are to be processed through K2 Commercial Hardware Customer Service without proper written authorization. Only orders with appropriate authorization will be processed.

Requests for systems information without proper authorization from the Facility Owner will be denied. Requests for information regarding the purchase of any systems support products as listed above will be referred to the local authorized sales agency.

Refer to current price lists for additional policies and procedures as they relate to this security policy.

Please remember: The purpose for the establishment of any security system is to provide an increased level of protection for the Facility Owner.



Keying Descriptions

- KD** **"Keyed Different"** - Each lock has an independant cut. (Can also be incorporated into a custom keyed system)
- KA** **"Keyed Alike"** - Group of two or more locks with the same key cut. (Can also be incorporated into a custom keyed system)
- CK** **"Construction Keyed"** [a.k.a. Protecto Keyed (PK) / Builder Keyed] - Temporary builder keyed system used during the construction phase. (We employ the "lost ball" method of construction keying)
- CMK** **"Construction Master Keyed"** - Combination of a construction key system and permanent master keyed system.
- Maison**** **"Keyed Common"** or **"Keyed to Pass"** - Lockset is keyed in a manner such that several random change keys (user) are able to pass through a common area.
- MK** **"Master Keyed"** - Simple two level system; A group of locks (KD, KA or both) that are operated by a change (user) key and a single master key.
- GMK** **"Grand Master Keyed"** - Three level system where one GMK (grand master key) opens all locks. Sub-master key (MK) only opens locks within its assigned group. All individual locks have their own random change (user) key.
- GGMK**** **"Great Grand Master Keyed"** - Four level sytem where on GGMK (great grand master key) opens all locks in the keyed system. Two different GMKs (grand master keys) open only specific locks in system. Two or more MKs (sub-master) only open assigned locks under their assigned GMK. All locks have their own random change (user) key. *Note: this type of system limits security.*
- SFIC Ready** Prepared to accept a Small Format Interchangeable Core (SFIC).
- LC** Locks shipped **"Less Cylinder"**
- ZB** Lock built with **"Zero Bitted Cylinder"** packed with two key blanks.

Controlled Cross Keying

A condition in which two or more different keys of the same level of keying and under the same higher level key(s) operate one cylinder by design; e.g., XAA1 operated by AA2 (but not XAA1 operated by AB1)

Uncontrolled Cross Keying

A condition in which two or more different keys under different higher level keys operate one cylinder by design; e.g., XAA1 operated by AB, AB1

NOTE: This condition could severely limit the security of the cylinder and the maximum expansion of the system when (1) more than a few of these different keys operate a cylinder, or (2) more than a few differently cross keyed cylinders per system are required. Uncontrolled Cross Keying is not recommended and often leads to key interchange.

* 6 pin keying is standard. KW can also be ordered with 5-pin option to match residential products.

** These multi-level keying systems may be limited when being requested with a 5-pin system.

Sample of GMK set up:

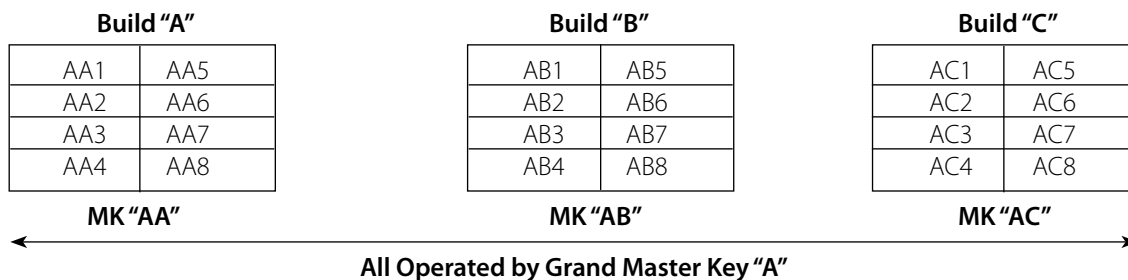

Sample of typical Maison set up:

(All Apt change keys to operate Maison lock)

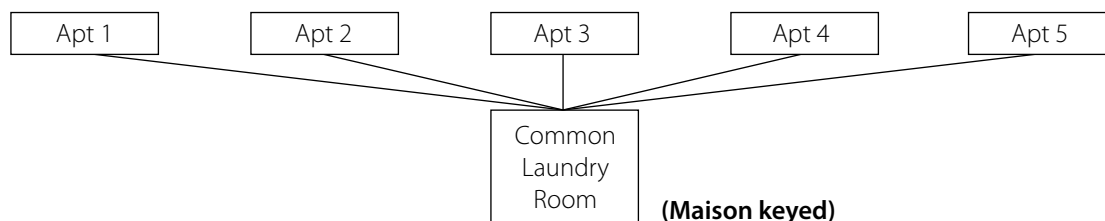



Keying Guide

Keying Options
Key Stamping

KEYING OPTIONS

Order	Description	List Price	Quantity
KD	Keyed Different	No Charge	1
KA	Keyed Alike	No Charge	1
MK	Master Keyed (One Level Only)	\$6.00	1
CK	Construction Keyed (AKA as Protecto Keying)	\$6.00	1
CMK	Construction & Master Keyed	\$8.50	1
MAIS	Maison Keyed / Cross Keyed	\$11.00	1
GMK	Grand Master Keyed	\$11.00	1
GGMK	Great Grand Master Keyed	\$11.00	1

KEY STAMPING OPTIONS

Order	Description	List Price	Quantity
VCK0	No bitting or keyset stamping on keys	No Charge	1
VCK1	Visual Key Stamping (Keys Only)	No Charge	1
VCK2	Special Key Stamping (Other than standard symbols)	\$3.00	1
VCK3	Visual Key Control (Cylinder Face Only - Levers and Deadbolts)	\$3.00	1
VCK4	Visual Key Control (Keys & Cylinder Face)	\$5.00	1
DND	Keys stamped with "Do Not Duplicate"	No Charge	1
CKC2	Concealed Key Control (Cylinders & VKC Keys)	\$5.00	1
CKC3	Concealed Key Control (Cylinders Only)	\$5.00	1

- Maximum Characters: Keys - 6

Cylinder Face - 4

CKC Cylinders - 6



KEY BLANKS (SOLD IN QUANTITIES OF 50)

Description	List Price	Each	Service Part #
6-PIN KEY BLANKS			
Kwikset KW 6-Pin Blank (K2 Bow, Embossed One Side)	\$1.25	1	8Q00039
Weiser WE 6-Pin Blank (K2 Bow, Embossed One Side)	\$1.25	1	8Q00040
Schlage SC 6-Pin Blank (K2 Bow, Embossed One Side)	\$1.25	1	8Q00041
Sargent LA 6-Pin Blank (Ilco Standard Bow)	\$1.25	1	8Q00043
Yale GA 6-Pin Blank (Ilco Standard Bow)	\$1.25	1	8Q00042
SFIC BF 6-Pin Blank (Ilco Standard Bow)	\$1.25	1	8Q00046
Kwikset KW 6-Pin Blank (K2 Bow, Embossed One Side, Do Not Duplicate)	\$1.25	1	8Q00047
Weiser WE 6-Pin Blank (K2 Bow, Embossed One Side, Do Not Duplicate)	\$1.25	1	8Q00048
Schlage SC 6-Pin Blank (K2 Bow, Embossed One Side, Do Not Duplicate)	\$1.25	1	8Q00049
SFIC BF 6-Pin Blank (Ilco Bow, Do Not Duplicate)	\$1.25	1	8Q00053
5-PIN KEY BLANKS			
Kwikset KW 5-Pin Blank (K2 Bow, Embossed One Side)	\$1.25	1	8Q00044
Kwikset KW 5-Pin Blank for QDB288 Control Cylinder	\$2.50	1	8Q00447
Weiser WE 5-Pin Blank (K2 Bow, Embossed One Side)	\$1.25	1	8Q00045
Schlage SC 5-Pin Blank (K2 Bow, Embossed One Side)	\$1.25	1	8Q00220
Kwikset KW 5-Pin Blank (K2 Bow, Embossed One Side, Do Not Duplicate)	\$1.25	1	8Q00050
Weiser WE 5-Pin Blank (K2 Bow, Embossed One Side, Do Not Duplicate)	\$1.25	1	8Q00051
Schlage SC 5-Pin Blank (K2 Bow, Embossed One Side, Do Not Duplicate)	\$1.25	1	8Q00052

* Key blanks sold in quantities of 50.



CUT KEYS

Description	List Price	Qty	Service Part #
6-PIN CUT KEYS			
Kwikset KW 6-Pin Cut Key (K2 Bow, Embossed One Side)	\$3.50	1	8Q00039-002
Kwikset KW 6-Pin Cut Key (K2 Bow, Embossed One Side, Construction Key)	\$3.50	1	9Q0009-036
Kwikset KW 6-Pin Cut Key (K2 Bow, Embossed One Side, Master Key)	\$3.50	1	9Q0009-037
Weiser WE 6-Pin Cut Key (K2 Bow, Embossed One Side)	\$3.50	1	8Q00040-002
Weiser WE 6-Pin Cut Key (K2 Bow, Embossed One Side, Construction Key)	\$3.50	1	9Q0009-038
Weiser WE 6-Pin Cut Key (K2 Bow, Embossed One Side, Master Key)	\$3.50	1	9Q0009-039
Schlage SC 6-Pin Cut Key (K2 Bow, Embossed One Side)	\$3.50	1	8Q00041-002
Schlage SC 6-Pin Cut Key (K2 Bow, Embossed One Side, Construction Key)	\$3.50	1	9Q0009-040
Schlage SC 6-Pin Cut Key (K2 Bow, Embossed One Side, Master Key)	\$3.50	1	9Q0009-041
Sargent LA 6-Pin Cut Key (Ilco Standard Bow)	\$3.50	1	8Q00043-002
Sargent LA 6-Pin Cut Key (Ilco Standard Bow, Construction Key)	\$3.50	1	9Q0009-044
Sargent LA 6-Pin Cut Key (Ilco Standard Bow, Master Key)	\$3.50	1	9Q0009-045
Yale GA 6-Pin Cut Key (Ilco Standard Bow)	\$3.50	1	8Q00042-002
Yale GA 6-Pin Cut Key (Ilco Standard Bow, Construction Key)	\$3.50	1	9Q0009-042
Yale GA 6-Pin Cut Key (Ilco Standard Bow, Master Key)	\$3.50	1	9Q0009-043
Kwikset KW 6-Pin Cut Key (K2 Bow, Embossed One Side, Do Not Duplicate)	\$3.50	1	9Q0009-024
Weiser WE 6-Pin Cut Key (K2 Bow, Embossed One Side, Do Not Duplicate)	\$3.50	1	9Q0009-026
Schlage SC 6-Pin Cut Key (K2 Bow, Embossed One Side, Do Not Duplicate)	\$3.50	1	9Q0009-028
5-PIN CUT KEYS			
Kwikset KW 5-Pin Cut Key (K2 Bow, Embossed One Side)	\$3.50	1	8Q00044-002
Kwikset KW 5-Pin Cut Key (K2 Bow, Embossed One Side, Construction Key)	\$3.50	1	9Q0009-046
Kwikset KW 5-Pin Cut Key (K2 Bow, Embossed One Side, Master Key)	\$3.50	1	9Q0009-047
Kwikset KW 5-Pin Cut Key for QDB288 Control Cylinder	\$3.50	1	9Q0009-094
Weiser WE 5-Pin Cut Key (K2 Bow, Embossed One Side)	\$3.50	1	8Q00045-002
Weiser WE 5-Pin Cut Key (K2 Bow, Embossed One Side, Construction Key)	\$3.50	1	9Q0009-048
Weiser WE 5-Pin Cut Key (K2 Bow, Embossed One Side, Master Key)	\$3.50	1	9Q0009-049
Schlage SC 5-Pin Cut Key (K2 Bow, Embossed One Side)	\$3.50	1	8Q00220-002
Schlage SC 5-Pin Cut Key (K2 Bow, Embossed One Side, Construction Key)	\$3.50	1	9Q0009-062
Schlage SC 5-Pin Cut Key (K2 Bow, Embossed One Side, Master Key)	\$3.50	1	9Q0009-061
Kwikset KW 5-Pin Cut Key (K2 Bow, Embossed One Side, Do Not Duplicate)	\$3.50	1	9Q0009-030
Weiser WE 5-Pin Cut Key (K2 Bow, Embossed One Side, Do Not Duplicate)	\$3.50	1	9Q0009-032
Schlage SC 5-Pin Cut Key (K2 Bow, Embossed One Side, Do Not Duplicate)	\$3.50	1	9Q0009-034

* All cut keys require specification of keyway and key combination.

* When being ordered separate from product Master Keys, Top Level Masters, and Do Not Duplicate Keys require **Signature Authority**.

* Builder key orders get 10 builder keys at no charge.

* Master key orders get 1 master key at no charge.



CYLINDER OPTIONS

Keyway	Series	Function	Model #	# of Pins	Keying	Service Part #	List Price	Qty
KEY-IN-LEVER CYLINDERS								
Kwikset KW	QCL100	Entry/Storeroom Cylinder	QCL150, QCL170	6-Pin	KD	8Q00001	\$11.00	1
		Classroom Cylinder	QCL160			8Q00004	\$11.00	1
		Entry/Storeroom/ Classroom Cylinder	QCL150, QCL160, QCL170	5-Pin	ZB, KA or Pinned	9Q0009-001	\$11.00	1
					All	9Q0009-006	\$11.00	1
	QCL200	Entry/Storeroom Cylinder	QCL250, QCL270	6-Pin	KD	8Q00007	\$11.00	1
						8Q00010	\$11.00	1
		Classroom Cylinder	QCL260	5-Pin	ZB, KA or Pinned	9Q0009-001	\$11.00	1
					All	9Q0009-006	\$11.00	1
	QCI200	Single/Double Locking Cylinder	QCI230, QCI250	6-Pin	KD	8Q00013	\$11.00	1
						ZB, KA or Pinned	9Q0009-001	\$11.00
	5-Pin	All	9Q0009-006	\$11.00	1			
QTL200	Entry/Storeroom Classroom Cylinder	QTL250, QTL260, QTL270	6-Pin	KD	8Q00013	\$11.00	1	
					ZB, KA or Pinned	9Q0009-001	\$11.00	1
	5-Pin	All	9Q0009-006	\$11.00	1			
Weiser WE	QCL100	Entry/Storeroom Cylinder	QCL150, QCL170	6-Pin	KD	8Q00002	\$11.00	1
		Classroom Cylinder	QCL160			8Q00005	\$11.00	1
		Entry/Storeroom/ Classroom Cylinder	QCL150, QCL160, QCL170	5-Pin	ZB, KA or Pinned	9Q0009-002	\$11.00	1
					All	9Q0009-007	\$11.00	1
	QCL200	Entry/Storeroom Cylinder	QCL250, QCL270	6-Pin	KD	8Q00008	\$11.00	1
						8Q00011	\$11.00	1
		Classroom Cylinder	QCL260	5-Pin	ZB, KA or Pinned	9Q0009-002	\$11.00	1
					All	9Q0009-007	\$11.00	1
	QCI200	Single/Double Locking Cylinder	QCI230, QCI250	6-Pin	KD	8Q00014	\$11.00	1
						ZB, KA or Pinned	9Q0009-002	\$11.00
	5-Pin	All	9Q0009-007	\$11.00	1			
QTL200	Entry/Storeroom/ Classroom Cylinder	QTL250, QTL260, QTL270	6-Pin	KD	8Q00014	\$11.00	1	
					ZB, KA or Pinned	9Q0009-002	\$11.00	1
			5-Pin	All	9Q0009-007	\$11.00	1	

CYLINDER FINISH CHART		
LOCK/CYLINDER FINISH	LOCK FINISH	CYLINDER FINISH
	605	606
	613	
	619	
	625	626
	626	



CYLINDER OPTIONS

Keyway	Series	Function	Model #	# of Pins	Keying	Service Part #	List Price	Qty
KEY-IN-LEVER CYLINDERS								
Schlage SC	QCL100	Entry/Storeroom Cylinder	QCL150, QCL170	6-Pin	KD	8Q00003	\$11.00	1
		Classroom Cylinder	QCL160			8Q00006	\$11.00	1
		Entry/Storeroom/Classroom Cylinder	QCL150, QCL160, QCL170	5-Pin	ZB, KA or Pinned	9Q0009-003	\$11.00	1
			QCL150, QCL160, QCL170		All	9Q0009-057	\$11.00	1
	QCL200	Entry/Storeroom Cylinder	QCL250, QCL270	6-Pin	KD	8Q00009	\$11.00	1
		Classroom Cylinder	QCL260			8Q00012	\$11.00	1
		Entry/Storeroom/Classroom Cylinder	QCL250, QCL260, QCL270	5-Pin	ZB, KA or Pinned	9Q0009-003	\$11.00	1
			QCL250, QCL260, QCL270		All	9Q0009-057	\$11.00	1
	QCI200	Single/Double Locking Cylinder	QCI230, QCI250	6-Pin	KD	8Q00015	\$11.00	1
				5-Pin		ZB, KA or Pinned	9Q0009-003	\$11.00
					All	9Q0009-057	\$11.00	1
	QTL200	Entry/Storeroom/Classroom Cylinder	QTL250, QTL260, QTL270	6-Pin	KD	8Q00015	\$11.00	1
				5-Pin		ZB, KA or Pinned	9Q0009-003	\$11.00
					All	9Q0009-057	\$11.00	1
	Yale GA	All Levers	Lever/Deadbolt Cylinder	ALL LEVER SERIES	6-Pin	All	9Q0009-004	\$43.00
Sargent LA	All Levers	Lever/Deadbolt Cylinder	ALL LEVER SERIES	6-Pin	All	9Q0009-005	\$43.00	1
SFIC BF	QTI100/ QCL200	Entry/Storeroom/Classroom SFIC Cylinder	ALL SFIC LEVERS	6-Pin	All*	8Q00036	\$34.00	1

* SFIC BF: Consult factory for keying lead times

CYLINDER FINISH CHART		
LOCK/CYLINDER FINISH	LOCK FINISH	CYLINDER FINISH
	605	606
	613	
	619	
	625	626
	626	



CYLINDER OPTIONS

Keyway	Series	Function	Model #	# of Pins	Keying	Service Part #	List Price	Qty
DEADBOLT CYLINDERS								
Kwikset KW	QDB100 / QDB200	Single Cylinder	QDB180, QDB280	6-Pin	KD	8Q00016	\$13.00	1
		Double Cylinder	QDB182, QDB282	6-Pin	KD	8Q00019	\$13.00	1
		Deadbolt Cylinder	QDB180, QDB182, QDB280, QDB282	6-Pin	ZB, KA or Pinned	9Q0009-050	\$13.00	1
		Deadbolt Cylinder		5-Pin	All	9Q0009-051	\$13.00	1
Weiser WE	QDB100 / QDB200	Single Cylinder	QDB180, QDB280	6-Pin	KD	8Q00017	\$13.00	1
		Double Cylinder	QDB182, QDB282	6-Pin	KD	8Q00020	\$13.00	1
		Deadbolt Cylinder	QDB180, QDB182, QDB280, QDB282	6-Pin	ZB, KA or Pinned	9Q0009-052	\$13.00	1
		Deadbolt Cylinder		5-Pin	All	9Q0009-053	\$13.00	1
Schlage SC	QDB100 / QDB200	Single Cylinder	QDB180, QDB280	6-Pin	KD	8Q00018	\$13.00	1
		Double Cylinder	QDB182, QDB282	6-Pin	KD	8Q00021	\$13.00	1
		Deadbolt Cylinder	QDB180, QDB182, QDB280, QDB282	6-Pin	ZB, KA or Pinned	9Q0009-054	\$13.00	1
		5-Pin Deadbolt Cylinder		5-Pin	All	9Q0009-060	\$13.00	1
Yale GA	QDB100 / QDB200	Lever/Deadbolt Cylinder	QDB180, QDB182, QDB280, QDB282	6-Pin	All	9Q0009-004	\$43.00	1
Sargent LA	QDB100 / QDB200	Lever/Deadbolt	QDB180, QDB182, QDB280, QDB282	6-Pin	All	9Q0009-005	\$43.00	1
SFIC BF	QDB100 / QDB200	SFIC Single Cylinder	QDB181, QDB281	6-Pin	All	8Q00037	\$34.00	1
		SFIC Double Cylinder	QDB183, QDB283	6-Pin	All*	8Q00038	\$34.00	1

* SFIC BF: Consult factory for keying lead times

CYLINDER FINISH CHART		
LOCK/CYLINDER FINISH	LOCK FINISH	CYLINDER FINISH
	605	606
	613	
	619	626
	625	
	626	



CYLINDER OPTIONS

Keyway	Function	Series	# of Pins	Keying	Service Part #	List Price	Qty
MORTISE CYLINDERS - 1" HOUSING, MORTISE CLOVERLEAF CAM							
Kwikset KW	Mortise Cylinder	QMS/QME/QML	5-Pin	KD, KA or Pinned	9Q0009-114	\$43.00	1
				ZB	8Q00502	\$43.00	1
Weiser WE	Mortise Cylinder		5-Pin	KD, KA or Pinned	9Q0009-115	\$43.00	1
				ZB	8Q00503	\$43.00	1
Schlage SC	Mortise Cylinder		5-Pin	KD, KA or Pinned	9Q0009-116	\$43.00	1
				ZB	8Q00504	\$43.00	1

** Consult factory for lead times*

CYLINDER FINISH CHART		
LOCK/CYLINDER FINISH	LOCK FINISH	CYLINDER FINISH
	605	605*
	606	606*
	613	690
	619	626
	625	625*
	626	626



CYLINDER OPTIONS

Keyway	Function	Series	# of Pins	Keying	Service Part #	List Price	Qty
MORTISE CYLINDERS - 1 1/8" HOUSING, MORTISE CLOVERLEAF CAM							
Kwikset KW	Mortise Cylinder	QMS/QME/QML	6-Pin	KD, KA or Pinned	9Q0009-118	\$43.00	1
				ZB	8Q00515	\$43.00	1
			5-Pin	KD, KA or Pinned	9Q0009-123	\$43.00	1
				ZB	8Q00516	\$43.00	1
Weiser WE	Mortise Cylinder		6-Pin	KD, KA or Pinned	9Q0009-119	\$43.00	1
				ZB	8Q00517	\$43.00	1
			5-Pin	KD, KA or Pinned	9Q0009-124	\$43.00	1
				ZB	8Q00518	\$43.00	1
Schlage SC	Mortise Cylinder		6-Pin	KD, KA or Pinned	9Q0009-120	\$43.00	1
				ZB	8Q00519	\$43.00	1
			5-Pin	KD, KA or Pinned	9Q0009-125	\$43.00	1
				ZB	8Q00520	\$43.00	1
Sargent LA	Mortise Cylinder	6-Pin	KD, KA or Pinned	9Q0009-122	\$43.00	1	
			ZB	8Q00522	\$43.00	1	
Yale GA	Mortise Cylinder	6-Pin	KD, KA or Pinned	9Q0009-121	\$43.00	1	
			ZB	8Q00521	\$43.00	1	

* Consult factory for lead times

CYLINDER FINISH CHART		
LOCK/CYLINDER FINISH	LOCK FINISH	CYLINDER FINISH
	605	605*
	606	606*
	613	690
	619	626
	625	625*
	626	626



CYLINDER OPTIONS

Keyway	Function	Series	# of Pins	Keying	Service Part #	List Price	Qty
MORTISE CYLINDERS - 1 1/8" HOUSING, STANDARD CAM							
Kwikset KW	Mortise Cylinder	Select Exit Devices & Trims	6-Pin	KD, KA or Pinned	9Q0009-010	\$43.00	1
				ZB	8Q00022	\$43.00	1
			5-Pin	KD, KA or Pinned	9Q0009-022	\$43.00	1
				ZB	8Q00023	\$43.00	1
Weiser WE	Mortise Cylinder	Select Exit Devices & Trims	6-Pin	KD, KA or Pinned	9Q0009-011	\$43.00	1
				ZB	8Q00024	\$43.00	1
			5-Pin	KD, KA or Pinned	9Q0009-023	\$43.00	1
				ZB	8Q00025	\$43.00	1
Schlage SC	Mortise Cylinder	Select Exit Devices & Trims	6-Pin	KD, KA or Pinned	9Q0009-012	\$43.00	1
				ZB	8Q00026	\$43.00	1
			5-Pin	KD, KA or Pinned	9Q0009-059	\$43.00	1
				ZB	8Q00054	\$43.00	1
Sargent LA	Mortise Cylinder	Select Exit Devices & Trims	6-Pin	KD, KA or Pinned	9Q0009-014	\$43.00	1
				ZB	8Q00028	\$43.00	1
Yale GA	Mortise Cylinder	Select Exit Devices & Trims	6-Pin	KD, KA or Pinned	9Q0009-013	\$43.00	1
				ZB	8Q00027	\$43.00	1
SFIC BF	Mortise Cylinder	Select Exit Devices & Trims	6-Pin	ALL*	8Q00238	\$66.00	1

* Consult factory for lead times

CYLINDER FINISH CHART		
	LOCK FINISH	CYLINDER FINISH
LOCK/CYLINDER FINISH	605	605*
	606	606*
	613	690
	619	626
	625	625*
	626	626



CYLINDER OPTIONS

Keyway	Function	Series	# of Pins	Keying	Service Part #	List Price	Qty
MORTISE CYLINDERS - 1¼" HOUSING, MORTISE CLOVERLEAF CAM							
Kwikset KW	Mortise Cylinder	QMS/QME/QML	6-Pin	KD, KA or Pinned	9Q0009-099	\$43.00	1
				ZB	8Q00487	\$43.00	1
Weiser WE	Mortise Cylinder		6-Pin	KD, KA or Pinned	9Q0009-100	\$43.00	1
				ZB	8Q00488	\$43.00	1
Schlage SC	Mortise Cylinder		6-Pin	KD, KA or Pinned	9Q0009-101	\$43.00	1
				ZB	8Q00489	\$43.00	1
Sargent LA*	Mortise Cylinder		6-Pin*	KD, KA or Pinned	9Q0009-103	\$43.00	1
				ZB	8Q00491	\$43.00	1
Yale GA*	Mortise Cylinder		6-Pin*	KD, KA or Pinned	9Q0009-102	\$43.00	1
				ZB	8Q00490	\$43.00	1

* Consult factory for lead times

CYLINDER FINISH CHART		
LOCK/CYLINDER FINISH	LOCK FINISH	CYLINDER FINISH
	605	605*
	606	606*
	613	690
	619	626
	625	625*
	626	626



CYLINDER OPTIONS

Keyway	Function	Series	# of Pins	Keying	Service Part #	List Price	Qty
MORTISE CYLINDERS - 1 3/8" HOUSING, MORTISE CLOVERLEAF CAM							
Kwikset KW	Mortise Cylinder	QMS/QME/QML	6-Pin	KD, KA or Pinned	9Q0009-104	\$43.00	1
				ZB	8Q00492	\$43.00	1
Weiser WE	Mortise Cylinder		6-Pin	KD, KA or Pinned	9Q0009-105	\$43.00	1
				ZB	8Q00493	\$43.00	1
Schlage SC	Mortise Cylinder		6-Pin	KD, KA or Pinned	9Q0009-106	\$43.00	1
				ZB	8Q00494	\$43.00	1
Sargent LA*	Mortise Cylinder		6-Pin*	KD, KA or Pinned	9Q0009-108	\$43.00	1
				ZB	8Q00496	\$43.00	1
Yale GA*	Mortise Cylinder		6-Pin*	KD, KA or Pinned	9Q0009-107	\$43.00	1
				ZB	8Q00495	\$43.00	1

* Consult factory for lead times

CYLINDER FINISH CHART		
LOCK/CYLINDER FINISH	LOCK FINISH	CYLINDER FINISH
	605	605*
	606	606*
	613	690
	619	626
	625	625*
	626	626



CYLINDER OPTIONS

Keyway	Function	Series	# of Pins	Keying	Service Part #	List Price	Qty
MORTISE CYLINDERS - 1½" HOUSING, MORTISE CLOVERLEAF CAM							
Kwikset KW	Mortise Cylinder	QMS/QME/QML	6-Pin	KD, KA or Pinned	9Q0009-109	\$43.00	1
				ZB	8Q00497	\$43.00	1
Weiser WE	Mortise Cylinder		6-Pin	KD, KA or Pinned	9Q0009-110	\$43.00	1
				ZB	8Q00498	\$43.00	1
Schlage SC	Mortise Cylinder		6-Pin	KD, KA or Pinned	9Q0009-111	\$43.00	1
				ZB	8Q00499	\$43.00	1
Sargent LA*	Mortise Cylinder		6-Pin*	KD, KA or Pinned	9Q0009-113	\$43.00	1
				ZB	8Q00501	\$43.00	1
Yale GA*	Mortise Cylinder		6-Pin*	KD, KA or Pinned	9Q0009-112	\$43.00	1
				ZB	8Q00500	\$43.00	1

* Consult factory for lead times

CYLINDER FINISH CHART		
LOCK/CYLINDER FINISH	LOCK FINISH	CYLINDER FINISH
	605	605*
	606	606*
	613	690
	619	626
	625	625*
	626	626



CYLINDER OPTIONS







Keyway	Function	Series	# of Pins	Keying	Service Part #	List Price	Qty
RIM CYLINDERS							
Kwikset KW	Rim Cylinder	Select Exit Trims	6-Pin	KD, KA or Pinned	9Q0009-015	\$43.00	1
			6-Pin	ZB	8Q00029	\$43.00	1
			5-Pin	KD, KA or Pinned	9Q0009-020	\$43.00	1
			5-Pin	ZB	8Q00030	\$43.00	1
Weiser WE	Rim Cylinder	Select Exit Trims	6-Pin	KD, KA or Pinned	9Q0009-016	\$43.00	1
			6-Pin	ZB	8Q00031	\$43.00	1
			5-Pin	KD, KA or Pinned	9Q0009-021	\$43.00	1
			5-Pin	ZB	8Q00032	\$43.00	1
Schlage SC	Rim Cylinder	Select Exit Trims	6-Pin	KD, KA or Pinned	9Q0009-017	\$43.00	1
			6-Pin	ZB	8Q00033	\$43.00	1
			5-Pin	KD, KA or Pinned	9Q0009-058	\$43.00	1
			5-Pin	ZB	8Q00055	\$43.00	1
Sargent LA	Rim Cylinder	Select Exit Trims	6-Pin	KD, KA or Pinned	9Q0009-019	\$43.00	1
			6-Pin	ZB	8Q00035	\$43.00	1
Yale GA	Rim Cylinder	Select Exit Trims	6-Pin	KD, KA or Pinned	9Q0009-018	\$43.00	1
			6-Pin	ZB	8Q00034	\$43.00	1
SFIC BF	Rim Cylinder	Select Exit Trims	6-Pin	ALL*	8Q00239	\$66.00	1

* SFIC BF: Consult factory for keying lead times

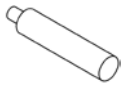
CYLINDER FINISH CHART		
	LOCK FINISH	CYLINDER FINISH
LOCK/CYLINDER FINISH	605	605
	606	606
	613	690
	619	626
	625	625
	626	626

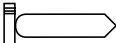
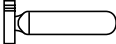
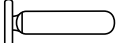

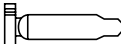
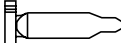

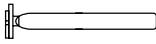





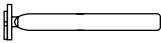

CYLINDER PARTS

Description		Series	Service Part #	List Price
	Cylinder Locking Pin	All	8Q00209	\$0.75
	Cylinder Locking Cap	All	8Q00210	\$1.25
	Cylinder Locking Spring	All	8Q00211	\$0.75
	Tailpiece QCL150/QCL170 - Entry/Storeroom	QCL100	8Q00069	\$1.75
	Tailpiece QCL160 - Classroom (all keyways except KW)	QCL100	8Q00070	\$1.75
	Tailpiece QCL160 - Classroom (KW keyway only)	QCL100	8Q00071	\$1.75
	Cylinder Plug Holder QCL100 Series	QCL100	8Q00065	\$1.25
	Tailpiece QCL250/QCL270/QCI250 - Entry/Storeroom/Interconnect	QCL200/ QCI200	8Q00072	\$1.75
	Tailpiece QCL260 - Classroom	QCL200	8Q00074	\$1.75
	SFIC Tailpiece QCL200 Series	QCL200	8Q00302	\$1.75
	Cylinder Plug Holder QCL200 Series	QCL200	8Q00066	\$1.25
	Tailpiece QCI200 Series Interconnect Deadbolt	QCI200	8Q00076	\$1.75



CYLINDER PARTS (CONTINUED)

Description		Series	Service Part #	List Price
	Tailpiece QTL200/QRT300 Series	QTL200/ QRT300	8Q00073	\$1.75
	Cylinder Plug Holder for QTL200 Series - Essex Style	QTL200	8Q00067	\$1.25
	Cylinder Plug Holder for QTL200 Series - Nordic Style	QTL200	8Q00068	\$1.25
	Tailpiece QDB100/QDB200 Series Single Cylinder	QDB100/ QDB200	8Q00083	\$1.75
	Tailpiece QDB100/QDB200 Series Double Cylinder (QTY 2)	QDB100/ QDB200	8Q00085	\$1.75
	Thick door kit - Tailpiece for QDB100/QDB200 Series Single Cylinder (1-3/4" - 2-1/4")	QDB100/ QDB200	8Q00084	\$1.75
	Cylinder Screw QDB100/QDB200 Series	QDB100/ QDB200	8Q00086	\$1.75
	Standard Cam for Mortise Cylinder	QED/ QET	8Q00119	\$1.25
	Cam Mounting Screws for Mortise Cylinders (QTY 2)	Mortise Cylinders	8Q00118	\$0.75
	Rim Cylinder Tailpiece	Rim Cylinders	8Q00140	\$1.75
	Rim Cylinder Tailpiece For Thick Doors	Rim Cylinders	8Q00480	\$1.75
	K2 Cloverleaf Mortise Cam for QME/QMS/QML	QME QMS QML	8Q01084	\$5.00



how to order: Grade 1 Extra Heavy Duty Mortise Levers

K2 Products are simple to order. Our numbering system follows a logical progression that enables you to make sure you get exactly what you need, the first time. We don't over complicate things, we keep it simple ... just part of being the "Easiest to do Business with"

If you have a question, feel free to call one of our customer service representatives, they are ready to assist you...866-590-2094

Single Dummy	20
Full Dummy	22
Passage	30
Privacy	40
Privacy w/ Deadbolt	45
Entry	50
Exit	52
Corridor	54
Dormitory	58
Classroom	60
Classroom Security	62
Apartment	64
Storeroom	70
Institutional	72
Store Door	74

605	Polished Brass
606	Satin Brass
613	Oil Rubbed Bronze
619	Satin Nickel
625	Polished Chrome
626	Satin Chrome

KD	Keyed Different
KA	Keyed Alike
CK	Construction Keyed
CMK	Construction Master Keyed
MAIS	Maison Keyed
MK	Master Keyed
GMK	Grand Master Keyed
GGMK	Great Grand Master Keyed
ZB	Zero Bitted

QME1	60	SIE	626	KW	KD	XXXX
Series	Function	Lever	Finish	Keyway	Keying	Notes

Escutcheon Trim	QME1
Sectional Trim	QMS1

Sierra	SIE
Summit	SUM

KW*	Kwikset "KW"
WE*	Weiser "E"
SC*	Schlage "C"
GA	Yale "GA"
LA	Sargent "LA"
LC	Less Cylinder

NOTES:

* KW, WE & SC available in either 6-pin or 5-pin

Example

If you ordered: QME160 SIE 626 KW KD

You would get: Grade 1 Classroom Mortise Lockset, Sierra Lever Escutcheon Trim, Satin Chrome Finish, Kwikset Keyway, Keyed Different.



QMS/QME

100 series
Grade 1 Extra Heavy Duty
Mortise Levers



Model/Series	Functions	Style	Price		Case Quantity	Cylinders
			626	605 [†] , 606 [†] , 613, 619 [†] , 625 [†]		
QMS120	Single Dummy	SIE/SUM	\$127.00	\$137.00	4	
QMS122	Full Dummy	SIE/SUM	\$254.00	\$264.00	4	
QMS130	Passage	SIE/SUM	\$390.00	\$400.00	4	
QMS140	Privacy	SIE/SUM	\$395.00	\$405.00	4	
QMS145*	Privacy w/ Deadbolt	SIE/SUM	\$420.00	\$430.00	4	
QMS150	Entry	SIE/SUM	\$460.00	\$470.00	4	Sgl
QMS152*	Exit	SIE/SUM	\$460.00	\$470.00	4	Sgl
QMS154*	Corridor	SIE/SUM	\$460.00	\$470.00	4	Sgl
QMS158	Dormitory	SIE/SUM	\$500.00	\$510.00	4	DbI
QMS160	Classroom	SIE/SUM	\$460.00	\$470.00	4	Sgl
QMS162*	Classroom Security	SIE/SUM	\$500.00	\$510.00	4	DbI
QMS164	Apartment	SIE/SUM	\$500.00	\$510.00	4	DbI
QMS170	Storeroom	SIE/SUM	\$460.00	\$470.00	4	Sgl
QMS172*	Institutional	SIE/SUM	\$500.00	\$510.00	4	DbI
QMS174*	Store Door	SIE/SUM	\$500.00	\$510.00	4	DbI

NOTES:

* Consult factory for lead times on specified functions.

† Consult factory for lead times on 605, 606, 619 & 625 finishes.

Prices include standard cylinders. Reference cylinder options for complete listing.



QMS/QME

100 series

Grade 1 Extra Heavy Duty Mortise Levers



Model/Series	Functions	Style	Price		Case Quantity	Cylinders
			626	605 [†] , 606 [†] , 613, 619 [†] , 625 [†]		
QME120	Single Dummy	SIE/SUM	\$160.00	\$170.00	4	
QME122	Full Dummy	SIE/SUM	\$319.00	\$329.00	4	
QME130	Passage	SIE/SUM	\$455.00	\$465.00	4	
QME140	Privacy	SIE/SUM	\$460.00	\$470.00	4	
QME145*	Privacy w/ Deadbolt	SIE/SUM	\$485.00	\$495.00	4	
QME150	Entry	SIE/SUM	\$525.00	\$535.00	4	Sgl
QME152*	Exit	SIE/SUM	\$525.00	\$535.00	4	Sgl
QME154*	Corridor	SIE/SUM	\$525.00	\$535.00	4	Sgl
QME158	Dormitory	SIE/SUM	\$565.00	\$575.00	4	Dbl
QME160	Classroom	SIE/SUM	\$525.00	\$535.00	4	Sgl
QME162*	Classroom Security	SIE/SUM	\$565.00	\$575.00	4	Dbl
QME164	Apartment	SIE/SUM	\$565.00	\$575.00	4	Dbl
QME170	Storeroom	SIE/SUM	\$525.00	\$535.00	4	Sgl
QME172*	Institutional	SIE/SUM	\$565.00	\$575.00	4	Dbl
QME174*	Store Door	SIE/SUM	\$565.00	\$575.00	4	Dbl

NOTES:

* Consult factory for lead times on specified functions.

† Consult factory for lead times on 605, 606, 619 & 625 finishes.

Prices include standard cylinders. Reference cylinder options for complete listing.



QMS/QME 100 series Grade 1 Extra Heavy Duty Mortise Levers

CYLINDER CHART - ESCUTCHEON TRIMS

NOTES:
 "-" Additional cylinder spacers not required.
 "N/A" Cylinder length not compatible with door thickness.

Model #	Door Thickness	Cylinder Length	Guard Dimension	Part Number	QTY	List Price	Model #	Door Thickness	Cylinder Length	Guard Dimension	Part Number	QTY*	List Price
Escutcheon Single Cylinder	1-3/4"	1"		-			Escutcheon Double Cylinder	1-3/4"	1"		-		
		1-1/8"		-					1-1/8"		N/A		
		1-1/4"		-					1-1/4"		N/A		
		1-3/8"	1/2"	8Q01086	1	\$18.00			1-3/8"	1/2"	8Q01086	1	\$18.00
		1-1/2"	1/2"	8Q01086	1	\$18.00			1-1/2"	5/8"	8Q01087	1	\$22.00
		1"		N/A					1"		N/A		
	2"	1-1/8"		-				1-1/8"		-			
		1-1/4"		-				1-1/4"		N/A			
		1-3/8"		-				1-3/8"		N/A			
		1-1/2"	1/2"	8Q01086	1	\$18.00		1-1/2"	1/2"	8Q01086	1	\$18.00	
		1"		N/A				1"		N/A			
		1-1/8"		N/A				1-1/8"		N/A			
	2-1/4"	1-1/4"		-				1-1/4"		-			
		1-3/8"		-				1-3/8"		-			
		1-1/2"		-				1-1/2"		N/A			
		1"		N/A				1"		N/A			
		1-1/8"		N/A				1-1/8"		N/A			
		1-1/4"		-				1-1/4"		-			

CYLINDER CHART - SECTIONAL TRIMS

NOTES:
 "-" Additional cylinder spacers not required.
 "N/A" Cylinder length not compatible with door thickness.

Model #	Door Thickness	Cylinder Length	Guard Dimension	Part Number	QTY	List Price	Model #	Door Thickness	Cylinder Length	Guard Dimension	Part Number	QTY*	List Price
Sectional Single Cylinder	1-3/4"	1"		-			Sectional Double Cylinder*	1-3/4"	1"		-		
		1-1/8"		-					1-1/8"	1/16"	8Q01088	1	\$10.00
		1-1/4"		-					1-1/4"	3/16"	8Q01089	1	\$14.00
		1-3/8"	3/16"	8Q01089	1	\$14.00			1-3/8"	5/16"	8Q01090	1	\$18.00
		1-1/2"	5/16"	8Q01090	1	\$18.00			1-1/2"	7/16"	8Q01091	1	\$22.00
		1"		N/A					1"		N/A		
	2"	1-1/8"		-				1-1/8"		-			
		1-1/4"		-				1-1/4"	1/16"	8Q01088	1	\$10.00	
		1-3/8"		-				1-3/8"	3/16"	8Q01089	1	\$14.00	
		1-1/2"	1/16"	8Q01088	1	\$10.00		1-1/2"	5/16"	8Q01090	1	\$18.00	
		1"		N/A				1"		N/A			
		1-1/8"		N/A				1-1/8"		N/A			
	2-1/4"	1-1/4"		-				1-1/4"		-			
		1-3/8"		-				1-3/8"	1/16"	8Q01088	1	\$10.00	
		1-1/2"		-				1-1/2"	3/16"	8Q01089	1	\$14.00	
		1"		N/A				1"		N/A			
		1-1/8"		N/A				1-1/8"		N/A			
		1-1/4"		-				1-1/4"		-			



QMS/QME

100 series

Grade 1 Extra Heavy Duty Mortise Levers

SECTIONAL TRIM KITS (SPECIFY FINISH WHEN ORDERING)

Sectional trim kits include interior and exterior trims, screw pack for trim installation and strike dust box. Trim kits are shipped in the standard mortise packaging allowing mortise cases to be configured for a complete lock.

Model #	Trim Description			Order Part #	List Price	List Price	QTY	Master Carton				
	Exterior (Secure)	Interior	Lever Style		626	603, 606, 613, 625, 626						
QMS130	Lever	Lever	Sierra (SIE)	8Q01093	\$254	\$264	1	4				
			Summit (SUM)	8Q01094								
QMS140	Lever, emergency access plate	Lever, turnpiece	Sierra (SIE)	8Q01066								
QMS145			Summit (SUM)	8Q01067								
QMS150	Lever, cylinder collar	Lever	Sierra (SIE)	8Q01072								
QMS160			Summit (SUM)	8Q01073								
QMS170												
QMS152	Lever, cylinder collar	Lever, turnpiece	Sierra (SIE)	8Q01070								
QMS154			Summit (SUM)	8Q01071								
QMS158	Lever, cylinder collar	Lever, cylinder collar	Sierra (SIE)	8Q01068								
QMS162												
QMS164			Summit (SUM)	8Q01069								
QMS172												
QMS174												
ALL	Cylinder collar kit (Includes standard cylinder guard, wave washer and gap washer)			8Q01016					\$30.00	\$30.00	1	1
ALL	Turnpiece assembly (Requires screw pack 8Q01030)			8Q01014					\$35.00	\$40.00	1	1



ESCUTCHEON TRIM KITS (SPECIFY FINISH WHEN ORDERING)

Escutcheon trim kits include interior and exterior trims, screw pack for trim installation and strike dust box. Trim kits are shipped in the standard mortise packaging allowing mortise cases to be configured for a complete lock.

Model #	Trim Description			Order Part #	List Price		QTY	Master Carton
	Exterior (Secure)	Interior	Lever Style		626	605,606,613, 619,625		
QME130	Lever	Lever	Sierra (SIE)	8Q01074	\$319	\$329	1	4
			Summit (SUM)	8Q01075				
QME140	Lever, emergency access hole	Lever, turnpiece	Sierra (SIE)	8Q01076				
QME145			Summit (SUM)	8Q01077				
QME150	Lever, cylinder hole	Lever	Sierra (SIE)	8Q01082				
QME160			Summit (SUM)	8Q01083				
QME170								
QME152	Lever, cylinder hole	Lever, turnpiece	Sierra (SIE)	8Q01080				
QME154			Summit (SUM)	8Q01081				
QME158	Lever, cylinder hole	Lever, cylinder hole	Sierra (SIE)	8Q01078				
QME162								
QME164			Summit (SUM)	8Q01079				
QME172								
QME174								



QMS/QME

100 series

Grade 1 Extra Heavy Duty Mortise Levers

MORTISE CASE KITS

Mortise case kits include case, instruction sheets & template, and case mounting screws.

Model #	Case Description		Order Part #	List Price	QTY
QMS/QME130	F01	Passage	8Q01059	\$115	1
QMS/QME140	F22	Privacy	8Q01054	\$120	
QMS/QME145	F19	Privacy with Deadbolt	8Q01061	\$145	
QMS/QME150	F04	Entry	8Q01058		
QMS/QME152	F13	Exit	8Q01063		
QMS/QME154	F20	Corridor	8Q01060		
QMS/QME158	F11	Dormitory	8Q01064		
QMS/QME160	F05	Classroom	8Q01057		
QMS/QME162	F32	Classroom Security	8Q01052		
QMS/QME164	F09	Apartment	8Q01055		
QMS/QME170	F07	Storeroom	8Q01056		
QMS/QME172	F30	Institutional	8Q01053		
QMS/QME174	F14	Store Door	8Q01062		

ARMOR FRONT KITS (SPECIFY FINISH WHEN ORDERING)

Armor front kits include a finished armor front and installation screws.

Model #	Description				Order Part #	List Price	QTY
	Latch	Deadbolt	Auxiliary	Toggle			
QMS/QME120					8Q01040	\$11	1
QMS/QME130	X				8Q01033		
QMS/QME140	X						
QMS/QME145					8Q01043		
QMS/QME152	X						
QMS/QME174							
QMS/QME150	X		X	X	8Q01042		
QMS/QME154	X	X		X	8Q01032		
QMS/QME158							
QMS/QME160					8Q01031		
QMS/QME162							
QMS/QME164	X		X				
QMS/QME170							
QMS/QME172							



QMS/QME

100 series

Grade 1 Extra Heavy Duty

Mortise Levers

STRIKE KITS (SPECIFY FINISH WHEN ORDERING)

Strike kits include finished strike and installation screws.

Model #	Strike Description	Order Part #	List Price	QTY
QMS/QME130	Strike for locks with latch bolt only or latch bolt with auxiliary.	8Q01035	\$10.00	1
QMS/QME140				
QMS/QME150				
QMS/QME160				
QMS/QME162				
QMS/QME164				
QMS/QME170				
QMS/QME172				
QMS/QME145	Strike for locks with latch bolt and dead bolt.	8Q01036		
QMS/QME152				
QMS/QME154				
QMS/QME158				
QMS/QME174				
ALL	Strike dust box, black plastic	8Q01045	\$5.00	1

SCREW PACKS AND OTHER PARTS

Part Description	Order Part #	List Price	QTY
Mortise case front bracket (bracket that connects armor front to lock case)	8Q01028	\$10.00	1
Screw pack - Trim only. Specify finish. (2 - M4x0.7 x 35mm flat head machine screws)	8Q01029	\$5.00	1
Screw pack - Turnpiece / Sectional Emergency Plate. Specify finish. (2 - M4 x 19mm flat head machine screws and 2 - #8-32 x 3/4" flat head wood screws)	8Q01030	\$5.00	1
Sectional Thick Door Kit - interior lever assembly for 2" - 2-1/4" doors	8Q01044	\$25.00	1
Spanner wrench for sectional lever installation	8Q01046	\$5.00	1
Screw pack - Armor Front. Specify finish. (2 - 0.7 x 5mm flat head machine screws)	8Q01047	\$4.50	1
Screw pack - Mortise Case.	8Q01048	\$5.00	1
Screw pack - Escutcheon Trims (for installation of trims, armor front and strike). Specify finish. (2 - M4 x 0.7 x 35mm flat head machine screws; 2 - #12 x 3/4" dual purpose screws; 2 - M4 x 0.7 x 5mm flat head machine screws)	8Q01049	\$10.00	1
Screw pack - Sectional Trims (for installation of trims, armor front and strike). Specify finish. (2 - M4 x 0.7 x 35mm flat head machine screws; 2 - #12 x 3/4" dual purpose screws; 2 - M4 x 0.7 x 5mm flat head machine screws; 2 - #8-32 x 3/4" flat head wood screws; 2 - M4 x 19mm flat head machine screws; 1/8" allen wrench)	8Q01050	\$12.00	1
Mortise cam - K2 Cloverleaf (All K2 Mortise Locks & Deadlocks)	8Q01084	\$5.00	1



CYLINDER OPTIONS (SPECIFY FINISH)

Order # With Lock	Description	Service Part #	List Price	Quantity
5-PIN MORTISE CYLINDERS - 1" Mortise Cloverleaf Cam				
KW-M5	Kwikset KW 5-Pin Mortise Cylinder	9Q0009-114	\$43.00	1
	Kwikset KW 5-Pin Mortise Cylinder (Zero Bitted)	8Q00502	\$43.00	1
WE-M5	Weiser WE 5-Pin Mortise Cylinder	9Q0009-115	\$43.00	1
	Weiser WE 5-Pin Mortise Cylinder (Zero Bitted)	8Q00503	\$43.00	1
SC-M5	Schlage SC 5-Pin Mortise Cylinder	9Q0009-116	\$43.00	1
	Schlage SC 5-Pin Mortise Cylinder (Zero Bitted)	8Q00504	\$43.00	1

* Consult factory for other cylinder options.

* Refer to cylinder, keys & keying section for keying charges and cylinder finishes.



CYLINDER OPTIONS (SPECIFY FINISH)

Order # With Lock	Description	Service Part #	List Price	Quantity
6-PIN MORTISE CYLINDERS - 1-1/8" Housing, Mortise Cloverleaf Cam				
KW-M6	Kwikset KW 6-Pin Mortise Cylinder	9Q0009-118	\$43.00	1
	Kwikset KW 6-Pin Mortise Cylinder (Zero Bitted)	8Q00515	\$43.00	1
WE-M6	Weiser WE 6-Pin Mortise Cylinder	9Q0009-119	\$43.00	1
	Weiser WE 6-Pin Mortise Cylinder (Zero Bitted)	8Q00517	\$43.00	1
SC-M6	Schlage SC 6-Pin Mortise Cylinder	9Q0009-120	\$43.00	1
	Schlage SC 6-Pin Mortise Cylinder (Zero Bitted)	8Q00519	\$43.00	1
LA-M6	Sargent LA 6-Pin Mortise Cylinder	9Q0009-122	\$43.00	1
	Sargent LA 6-Pin Mortise Cylinder (Zero Bitted)	8Q00522	\$43.00	1
GA-M6	Yale GA 6-Pin Mortise Cylinder	9Q0009-121	\$43.00	1
	Yale GA 6-Pin Mortise Cylinder (Zero Bitted)	8Q00521	\$43.00	1
5-PIN MORTISE CYLINDERS - 1-1/8" Housing, Mortise Cloverleaf Cam				
KW-M5	Kwikset KW 5-Pin Mortise Cylinder	9Q0009-123	\$43.00	1
	Kwikset KW 5-Pin Mortise Cylinder (Zero Bitted)	8Q00516	\$43.00	1
WE-M5	Weiser WE 5-Pin Mortise Cylinder	9Q0009-124	\$43.00	1
	Weiser WE 5-Pin Mortise Cylinder (Zero Bitted)	8Q00518	\$43.00	1
SC-M5	Schlage SC 5-Pin Mortise Cylinder	9Q0009-125	\$43.00	1
	Schlage SC 5-Pin Mortise Cylinder (Zero Bitted)	8Q00520	\$43.00	1

* Consult factory for other cylinder options.

* Refer to cylinder, keys & keying section for keying charges and cylinder finishes.



CYLINDER OPTIONS (SPECIFY FINISH)

Order # With Lock	Description	Service Part #	List Price	Quantity
6-PIN MORTISE CYLINDERS - 1-1/4" Housing, Mortise Cloverleaf Cam				
KW-M6	Kwikset KW 6-Pin Mortise Cylinder	9Q0009-099	\$43.00	1
	Kwikset KW 6-Pin Mortise Cylinder (Zero Bitted)	8Q00487	\$43.00	1
WE-M6	Weiser WE 6-Pin Mortise Cylinder	9Q0009-100	\$43.00	1
	Weiser WE 6-Pin Mortise Cylinder (Zero Bitted)	8Q00488	\$43.00	1
SC-M6	Schlage SC 6-Pin Mortise Cylinder	9Q0009-101	\$43.00	1
	Schlage SC 6-Pin Mortise Cylinder (Zero Bitted)	8Q00489	\$43.00	1
LA-M6*	Sargent LA 6-Pin Mortise Cylinder	9Q0009-103	\$43.00	1
	Sargent LA 6-Pin Mortise Cylinder (Zero Bitted)	8Q00491	\$43.00	1
GA-M6*	Yale GA 6-Pin Mortise Cylinder	9Q0009-102	\$43.00	1
	Yale GA 6-Pin Mortise Cylinder (Zero Bitted)	8Q00490	\$43.00	1

* Consult factory for other cylinder options.

* Refer to cylinder, keys & keying section for keying charges and cylinder finishes.



CYLINDER OPTIONS (SPECIFY FINISH)

Order # With Lock	Description	Service Part #	List Price	Quantity
6-PIN MORTISE CYLINDERS - 1-3/8" Housing, Mortise Cloverleaf Cam				
KW-M6	Kwikset KW 6-Pin Mortise Cylinder	9Q0009-104	\$43.00	1
	Kwikset KW 6-Pin Mortise Cylinder (Zero Bitted)	8Q00492	\$43.00	1
WE-M6	Weiser WE 6-Pin Mortise Cylinder	9Q0009-105	\$43.00	1
	Weiser WE 6-Pin Mortise Cylinder (Zero Bitted)	8Q00493	\$43.00	1
SC-M6	Schlage SC 6-Pin Mortise Cylinder	9Q0009-106	\$43.00	1
	Schlage SC 6-Pin Mortise Cylinder (Zero Bitted)	8Q00494	\$43.00	1
LA-M6*	Sargent LA 6-Pin Mortise Cylinder	9Q0009-108	\$43.00	1
	Sargent LA 6-Pin Mortise Cylinder (Zero Bitted)	8Q00496	\$43.00	1
GA-M6*	Yale GA 6-Pin Mortise Cylinder	9Q0009-107	\$43.00	1
	Yale GA 6-Pin Mortise Cylinder (Zero Bitted)	8Q00495	\$43.00	1

* Consult factory for other cylinder options.

* Refer to cylinder, keys & keying section for keying charges and cylinder finishes.



CYLINDER OPTIONS (SPECIFY FINISH)

Order # With Lock	Description	Service Part #	List Price	Quantity
6-PIN MORTISE CYLINDERS - 1-½" Housing, Mortise Cloverleaf Cam				
KW-M6	Kwikset KW 6-Pin Mortise Cylinder	9Q0009-109	\$43.00	1
	Kwikset KW 6-Pin Mortise Cylinder (Zero Bitted)	8Q00497	\$43.00	1
WE-M6	Weiser WE 6-Pin Mortise Cylinder	9Q0009-110	\$43.00	1
	Weiser WE 6-Pin Mortise Cylinder (Zero Bitted)	8Q00498	\$43.00	1
SC-M6	Schlage SC 6-Pin Mortise Cylinder	9Q0009-111	\$43.00	1
	Schlage SC 6-Pin Mortise Cylinder (Zero Bitted)	8Q00499	\$43.00	1
LA-M6*	Sargent LA 6-Pin Mortise Cylinder	9Q0009-113	\$43.00	1
	Sargent LA 6-Pin Mortise Cylinder (Zero Bitted)	8Q00501	\$43.00	1
GA-M6*	Yale GA 6-Pin Mortise Cylinder	9Q0009-112	\$43.00	1
	Yale GA 6-Pin Mortise Cylinder (Zero Bitted)	8Q00500	\$43.00	1

* Consult factory for other cylinder options.

* Refer to cylinder, keys & keying section for keying charges and cylinder finishes.



how to order: Grade 1 Extra Heavy Duty Mortise Deadlocks

K2 Products are simple to order. Our numbering system follows a logical progression that enables you to make sure you get exactly what you need, the first time. We don't over complicate things, we keep it simple ... just part of being the "Easiest to do Business with"

If you have a question, feel free to call one of our customer service representatives, they are ready to assist you...866-590-2094

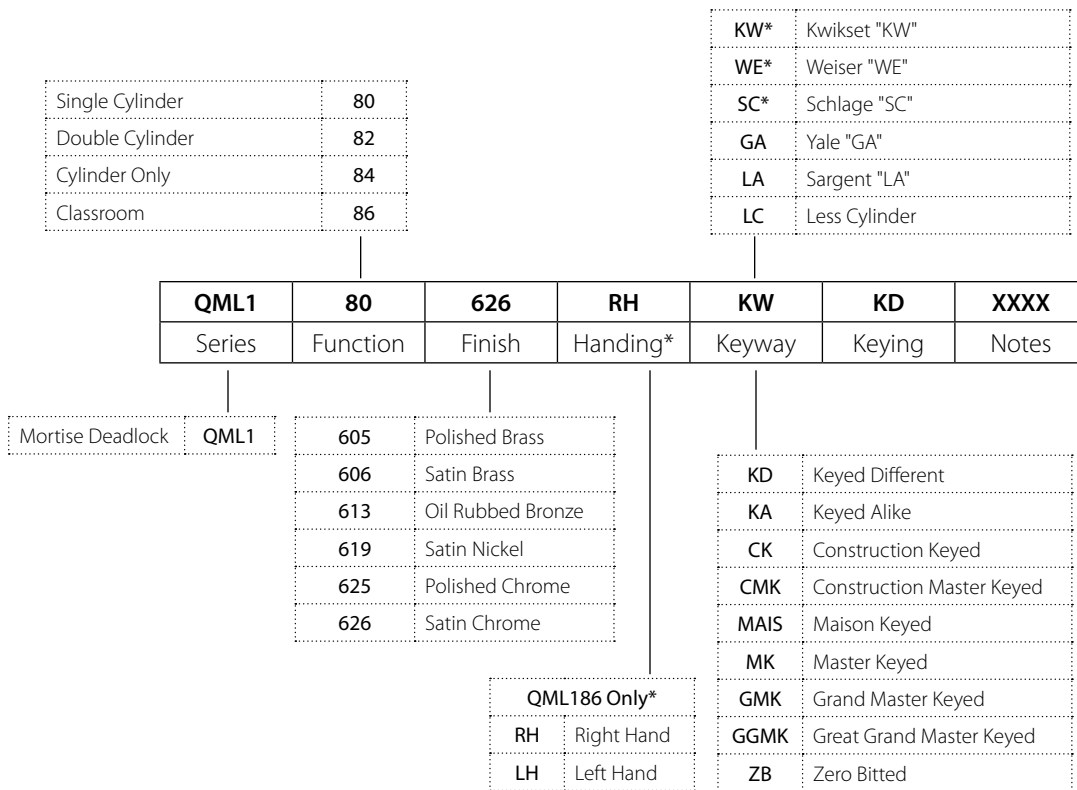

NOTES:

* KW, WE & SC available in either 6-pin or 5-pin

Example

If you ordered: QML 180 626 KW KD

You would get: Grade 1 Single Cylinder Mortise Deadlock, Satin Chrome Finish, Kwikset Keyway, Keyed Different.



QMS/QME
100 series
Grade 1 Extra Heavy Duty
Mortise Deadlocks

QML 180



Model/Series	Functions	Price		Case Quantity
		626	605 †, 606 †, 613, 619 †, 625 †	
QML180	Single Cylinder	\$225.00	\$235.00	10
QML182	Double Cylinder	\$255.00	\$265.00	10
QML184	Cylinder Only	\$190.00	\$190.00	10
QML186*	Classroom	\$230.00	\$235.00	10

NOTES:

† Consult factory for lead times on 605, 606, 619 & 625 finishes.

* Classroom function requires handed cylinder turn. Specify handing when ordering.

Prices include standard cylinders. Reference cylinder options for complete listing.



MORTISE DEADLOCK KITS

Mortise deadlock kits include case, instruction sheets & template, and case mounting screws.				
Model #	Description	Order Part #	List Price	QTY
ALL QML	Mortise deadlock case	8Q01051	\$110.00	1

ARMOR FRONT KITS (SPECIFY FINISH WHEN ORDERING)

Armor front kits include a finished armor front and installation screws.				
Model #	Description	Order Part #	List Price	QTY
ALL QML	Mortise deadlock armor front	8Q01039	\$8.00	1

STRIKE KITS (SPECIFY FINISH WHEN ORDERING)

Strike kits include finished strike and installation screws.				
Model #	Description	Order Part #	List Price	QTY
ALL QML	Mortise deadlock strike	8Q01034	\$7.00	1
ALL QML	Deadlock strike dust box, black plastic	8Q01085	\$5.00	1

DEADLOCK TRIM KITS (SPECIFY FINISH WHEN ORDERING)

Description	Order Part #	List Price	List Price	QTY
		626	605, 606, 613, 619, 625	
Cylinder guard kit (Includes standard cylinder guard, wave washer and gap washer)	8Q01016	\$25.00	\$30.00	1
Turnpiece assembly (Requires screw pack 8Q01030)	8Q01014	\$35.00	\$40.00	1



MORTISE DEADLOCK KITS

Mortise deadlock kits include case, instruction sheets & template, and case mounting screws.				
Model #	Description	Order Part #	List Price	QTY
ALL QML	Mortise deadlock case	8Q01051	\$110.00	1

ARMOR FRONT KITS (SPECIFY FINISH WHEN ORDERING)

Armor front kits include a finished armor front and installation screws.				
Model #	Description	Order Part #	List Price	QTY
ALL QML	Mortise deadlock armor front	8Q01039	\$8.00	1

STRIKE KITS (SPECIFY FINISH WHEN ORDERING)

Strike kits include finished strike and installation screws.				
Model #	Description	Order Part #	List Price	QTY
ALL QML	Mortise deadlock strike	8Q01034	\$7.00	1
ALL QML	Deadlock strike dust box, black plastic	8Q01085	\$5.00	1

DEADLOCK TRIM KITS (SPECIFY FINISH WHEN ORDERING)

Description	Order Part #	List Price	List Price	QTY
		626	605, 606, 613, 619, 625	
Cylinder guard kit (Includes standard cylinder guard, wave washer and gap washer)	8Q01016	\$25.00	\$30.00	1
Turnpiece assembly (Requires screw pack 8Q01030)	8Q01014	\$35.00	\$40.00	1



how to order: Grade 1 Extra Heavy Duty Cylindrical Levers

K2 Products are simple to order. Our numbering system follows a logical progression that enables you to make sure you get exactly what you need, the first time. We don't over complicate things, we keep it simple ... just part of being the "Easiest to do Business with"

If you have a question, feel free to call one of our customer service representatives, they are ready to assist you...866-590-2094

Dummy Trim	20
Passage	30
Communicating Lock	35
Privacy	40
Entry/Office Lock	50
Classroom Lock	60
Storeroom Lock	70

605	Bright Brass
613	Oil Rubbed Bronze
619	Satin Nickel
625	Bright Chrome
626	Satin Chrome
626x625	Satin Chrome x Bright Chrome (Privacy Only)

KW*	Kwikset "KW"
WE*	Weiser "E"
SC*	Schlage "C"
GA	Yale "GA"
LA	Sargent "LA"
LC	Less Cylinder

QCL1	70	EUX	SIE	626	234DS	478S	24V	KW	CK	XXXX
Series	Function	Electrification	Design	Finish	Latch	Strike	Power	Keyway	Keying	Notes

Grade 1 Cylindrical	QCL1xx
---------------------	---------------

Sierra	SIE
Summit	SUM

Electronically Locked (fail-safe)	EL
Electronically Unlocked (fail-secure)	EU
Request to Exit	X
Electronically locked (fail-secure) with request to exit	ELX
Electronically unlocked (fail-safe) with request to exit	EUX

2 3/4" Deadlatch Square	234DS
2 3/4" Deadlatch Radius	234DR
2 3/8" Deadlatch Square	238DS
2 3/8" Deadlatch Radius	238DR
2 3/4" Springlatch Square	234SS
2 3/4" Springlatch Radius	234SR
2 3/8" Springlatch Square	238SS
2 3/8" Springlatch Radius	238SR
5" Deadlatch Square	500DS
5" Springlatch Square	500SS
2 3/4" Deadlatch Square 3/4" Throw	234DSF
2 3/4" Deadlatch Radius 3/4" Throw	234DRF

KD	Keyed Different
KA	Keyed Alike
CK	Construction Keyed
CMK	Construction Master Keyed
MAIS	Maison Keyed
MK	Master Keyed
GMK	Grand Master Keyed
GGMK	Great Grand Master Keyed
ZB	Zero Bitted

Electrification Only	
24V	24 Volt AC/DC
12V	12 Volt AC/DC

478S	ANSI 4 7/8" x 1 1/4" Strike
118F	1 1/8" x 2 3/4" T-Strike

* Available in 6-pin & 5-pin. 6-pin is standard.

Example

If you ordered: QCL170 SIE 626 234DS 478S KW CK KD

You would get: Grade 1 Cylindrical Storeroom Lever, Sierra, Satin Chrome, 2 3/4" Deadlatch Square, ANSI 4 7/8" x 1 1/4" Strike, Kwikset Keyway, Construction Keyed, Keyed Different.



QCL100 series

Grade 1 Extra Heavy Duty Cylindrical Levers

Sierra (SIE)



Available in: 605, 613, 619, 625, 626
 Privacy split available in: 626 x 625*

Summit (SUM)



Available in: 605, 613, 619, 625, 626
 Privacy split available in: 626 x 625*

Model/Series	Functions	Style	Price		Case Quantity
			626	605, 613, 619, 625	
QCL120	Half Dummy	SIE/SUM	\$86.00	\$91.00	12
QCL130	Passage	SIE/SUM	\$171.00	\$181.00	6
QCL135	Communicating	SIE/SUM	\$193.00	\$203.00	6
QCL140*	Privacy	SIE/SUM	\$193.00	\$203.00	6
QCL150	Entrance/Office	SIE/SUM	\$235.00	\$245.00	6
QCL160	Classroom	SIE/SUM	\$235.00	\$245.00	6
QCL170	Storeroom	SIE/SUM	\$235.00	\$245.00	6

NOTES:

* Privacy split finishes are priced at the highest finish price.
 Refer to page E-5 for electrified options.



QCL100 series

Grade 1 Extra Heavy Duty Cylindrical Levers

ELECTRIFIED OPTIONS (CONSULT FACTORY FOR LEAD TIMES)



Model #	Description	List Price Adder
QCL170EL	Electronically locked (fail safe). Outside lever continuously locked electrically. Unlocked by key outside, by switch, or by power failure. Inside always free for immediate egress.	\$246.00
QCL170EU	Electronically unlocked (fail secure). Outside lever continuously locked until unlocked by key or electric current. Inside always free for immediate egress.	\$246.00
QCL170X	Request to exit. Switch monitors inside lever rotation. Incorporates into alarm systems or in conjunction with an electromagnet.	\$215.00
QCL170ELX	Electronically locked (fail safe) with request to exit. Outside lever continuously locked electrically. Unlocked by key outside, by switch, or by power failure. Inside always free for immediate egress. Ability to tie into alarm systems.	\$406.00
QCL170EUX	Electronically unlocked (fail secure) with request to exit. Outside lever continuously locked until unlocked by key or electric current. Inside always free for immediate egress. Ability to tie into alarm systems.	\$406.00
8Q00314	Fail Safe / Fail Secure 24VDC Power Supply	\$615.00

Electrified Product Specifications

- Consult Factory for lead times.
- Electrification prices should be added to list price of lock.
- Standard door prep.
- Deadlocking latch.
- Key override allows key to retract latchbolt momentarily on electronically locked models.
- Inside lever always free for immediate egress.
- Continuous duty solenoids.
- Tie into alarm systems and electromagnetic locks.
- 12V AC/DC with .250 amp current.
- 24V AC/DC with .150 amp current.
- **Specify voltage when ordering.**
- Lifetime warranty on lock body; 1 year warranty on electric components.
- Uses power supply 8Q00314.
- Warranty: 1 Year Electrical.

Power Supply Specifications

- Consult Factory for lead times.
- Provides power for fail safe or fail secure locking devices.
- UL listed, US & Canada, Class 2.
- Filtered and regulated 24DC constant voltage.
- 2 AMP load capacity.
- Over voltage/short circuit protection.
- Surge suppression for locking devices.
- Interface relay to isolate the locking device current from the control switch.
- Auxilliary 24VDC constant voltage for powering stand alone devices such as keypads, motion detectors, status indicators, etc.
- Field terminal block set at 45° for ease of installation.
- Can power up to 12 24V Cylindrical fail safe/ fail secure levers - refer to installation manual for additional details.



QCL100 series

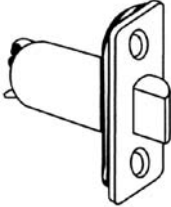
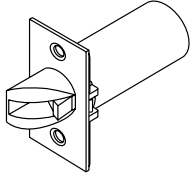

Grade 1 Extra Heavy Duty Cylindrical Levers

LATCH OPTIONS (SPECIFY FINISH)

Order # With Lock	Description	Price With Lock	Service Part #	Service Part List Price
1 1/8" X 2 1/4" FACE PLATE, 1" HOUSING DIAMETER, GRADE 1, UL (WIDE FACE)				
Grade 1 - Deadlatch 	234DS	2 3/4" dead latch - square corner	No Charge	8Q00172 \$7.00
	234DR	2 3/4" dead latch - radius corner	No Charge	8Q00171 \$7.00
	238DS	2 3/8" dead latch - square corner	No Charge	8Q00174 \$7.00
	238DR	2 3/8" dead latch - radius corner	No Charge	8Q00173 \$7.00
	500DS	5" dead latch - square corner	Add \$15.50	8Q00175 \$23.50
Grade 1 - Springlatch 	234SS	2 3/4" spring latch privacy - square corner	No Charge	8Q00177 \$7.00
		2 3/4" spring latch passage - square corner	No Charge	8Q00182 \$7.00
	234SR	2 3/4" spring latch privacy - radius corner	No Charge	8Q00176 \$7.00
		2 3/4" spring latch passage - radius corner	No Charge	8Q00181 \$7.00
	238SS	2 3/8" spring latch privacy - square corner	No Charge	8Q00179 \$7.00
		2 3/8" spring latch passage - square corner	No Charge	8Q00184 \$7.00
	238SR	2 3/8" spring latch privacy - radius corner	No Charge	8Q00178 \$7.00
		2 3/8" spring latch passage - radius corner	No Charge	8Q00183 \$7.00
	500SS	5" spring latch privacy - square corner	Add \$15.50	8Q00180 \$23.50
		5" spring latch passage - square corner	Add \$15.50	8Q00185 \$23.50
1 1/8" X 2 1/4" FACE PLATE, 1" HOUSING DIAMETER, GRADE 1, 3/4" THROW, 3 HR UL				
	234DSF	2 3/4" dead latch - square corner, 3/4" throw	Add \$73.50	8Q00438 \$80.00
	234DRF	2 3/4" dead latch - radius corner, 3/4" throw	Add \$73.50	8Q00437 \$80.00
NO LATCH				
NOL	No Latch	Deduct \$7.00		



STRIKE OPTIONS (SPECIFY FINISH)

Order # With Lock		Description	Price With Lock	Service Part #	Service Part List Price
	118F	1 1/8" x 2 3/4" T-Strike (Does not include screws. Screwpack 8Q00058)	Deduct \$2.00	8Q00165	\$3.00
	478S	4 7/8" x 1 1/4" ANSI Strike (Does not include screws.)	No Charge	8Q00166	\$5.00
NO STRIKE					
NOS		No Strike	Deduct \$5.00		



QCL100 series

Grade 1 Extra Heavy Duty Cylindrical Levers

CYLINDER OPTIONS (SPECIFY FINISH)

Order # With Lock	Description	Price With Lock	Service Part #	Service Part List Price
6-PIN BRASS CYLINDERS				
KW6	Kwikset KW - 6-Pin Entry/Storeroom Cylinder (KD)	No Charge	8Q00001	\$11.00
	Kwikset KW - 6-Pin Classroom Cylinder (KD)	No Charge	8Q00004	\$11.00
	Kwikset KW - 6-Pin Entry/Storeroom/Classroom Cylinder (ZB or Pinned)	No Charge	9Q0009-001	\$11.00
WE6	Weiser WE - 6-Pin Entry/Storeroom Cylinder (KD)	No Charge	8Q00002	\$11.00
	Weiser WE - 6-Pin Classroom Cylinder (KD)	No Charge	8Q00005	\$11.00
	Weiser WE - 6-Pin Entry/Storeroom/Storeroom Cylinder (ZB or Pinned)	No Charge	9Q0009-002	\$11.00
SC6	Schlage SC - 6-Pin Entry/Storeroom Cylinder (KD)	No Charge	8Q00003	\$11.00
	Schlage SC - 6-Pin Classroom Cylinder (KD)	No Charge	8Q00006	\$11.00
	Schlage SC - 6-Pin Entry/Storeroom/Classroom Cylinder (ZB or Pinned)	No Charge	9Q0009-003	\$11.00
GA6	Yale GA - 6-Pin Lever/Deadbolt Cylinder (KD Only)	No Charge	9Q0009-004	\$43.00
LA6	Sargent LA - 6-Pin Lever/Deadbolt Cylinder (KD Only)	No Charge	9Q0009-005	\$43.00
5-PIN BRASS CYLINDERS				
KW5	Kwikset KW - 5-Pin Entry/Storeroom/Classroom Cylinder (ZB or Pinned)	No Charge	9Q0009-006	\$11.00
WE5	Weiser WE - 5-Pin Entry/Storeroom/Storeroom Cylinder (ZB or Pinned)	No Charge	9Q0009-007	\$11.00
SC5	Schlage SC - 5-Pin Entry/Storeroom/Classroom Cylinder (ZB or Pinned)	No Charge	9Q0009-057	\$11.00
LESS CYLINDER				
LC	Less Cylinder	Deduct \$11		

* Consult factory for other cylinder options.







* Refer to cylinder, keys & keying section for keying charges and cylinder finishes.

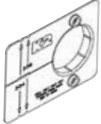
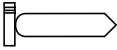
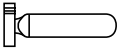
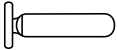

QCL100 series

Grade 1 Extra Heavy Duty Cylindrical Levers

OTHER PARTS & SCREW PACKS

Description	Service Part #	Service Part List Price	
	Installation Jig for Cylindrical Levers	8Q00075	\$6.50
	Tailpiece QCL150/QCL170 - Entry/Storeroom	8Q00069	\$1.75
	Tailpiece QCL160 - Classroom (all keyways except KW)	8Q00070	\$1.75
	Tailpiece QCL160 - Classroom (KW keyway only)	8Q00071	\$1.75
	Cylinder Plug Holder QCL100 Series	8Q00065	\$1.25
	Screw Pack for QCL100 Series Dummy (Specify finish)	8Q00056	\$1.25
	Screw Pack for QCL100 Series (Specify finish)	8Q00057	\$1.75
	Screw Pack for T-Strike (Specify finish)	8Q00058	\$1.25
	Trim Ring for Cylindrical Locks (Shims Lock off door approximately 1/8") (Available in 605, 613, 619, 626)	8Q00221	\$15.50



how to order: Grade 2 Cylindrical Levers

K2 Products are simple to order. Our numbering system follows a logical progression that enables you to make sure you get exactly what you need, the first time. We don't over complicate things, we keep it simple ... just part of being the "Easiest to do Business with"

If you have a question, feel free to call one of our customer service representatives, they are ready to assist you...866-590-2094

Dummy Trim	20
Passage	30
Communicating Lock	35
Privacy	40
Entry/Office Lock	50
Classroom Lock	60
Storeroom Lock	70

605	Bright Brass
613	Oil Rubbed Bronze
619	Satin Nickel
625	Bright Chrome
626	Satin Chrome
626 x 625	Satin Chrome x Bright Chrome (Privacy Only)
626 x 613	Satin Chrome x Oil Rubbed Bronze (Privacy Only)

KW*	Kwikset "KW"
WE*	Weiser "E"
SC*	Schlage "C"
GA	Yale "GA"
LA	Sargent "LA"
LC	Less Cylinder

QCL2	70	PNN	626	234DS	478S	KW	CK	XXXX
Series	Function	Design	Finish	Latch	Strike	Keyway	Keying	Notes

Grade 2 Cylindrical	QCL2xx
---------------------	--------

Pinnacle	PNN
Pearce	PEA

2 3/4" Deadlatch Square - 1" face	234DSN
2 3/4" Deadlatch Radius - 1" face	234DRN
2 3/8" Deadlatch Square - 1" face	238DSN
2 3/8" Deadlatch Radius - 1" face	234DRN
2 3/4" Springlatch Square - 1" face	234SSN
2 3/4" Springlatch Radius - 1" face	234SRN
2 3/8" Springlatch Square - 1" face	238SSN
2 3/8" Springlatch Radius - 1" face	238SRN
2 3/4" Deadlatch Square - 1 1/8" face	234DS
2 3/4" Deadlatch Radius - 1 1/8" face	234DR
2 3/8" Deadlatch Square - 1 1/8" face	238DS
2 3/8" Deadlatch Radius - 1 1/8" face	238DR
2 3/4" Springlatch Square - 1 1/8" face	234SS
2 3/4" Springlatch Radius - 1 1/8" face	234SR
2 3/8" Springlatch Square - 1 1/8" face	238SS
2 3/8" Springlatch Radius - 1 1/8" face	238SR
3 3/4" Deadlatch Square - 1 1/8" face	334DS
3 3/4" Springlatch Square - 1 1/8" face	334SS
5" Deadlatch Square - 1 1/8" face	500DS
5" Springlatch Square - 1 1/8" face	500SS
2 3/4" Deadlatch Square - 3/4" throw	234DSF
2 3/4" Deadlatch Radius - 3/4" throw	234DRF

KD	Keyed Different
KA	Keyed Alike
CK	Construction Keyed
CMK	Construction Master Keyed
MAIS	Maison Keyed
MK	Master Keyed
GMK	Grand Master Keyed
GGMK	Great Grand Master Keyed
ZB	Zero Bitted

478S	ANSI 4 7/8" x 1 1/4" Strike
118F	1 1/8" x 2 3/4" T-Strike
FLS	Full Lip Square Corner Strike
FLR	Full Lip 1/4" Radius Corner Strike

* Available in 6-pin & 5-pin. 6-pin is standard.

Example

If you ordered: QCL270 PNN 626 234DS 487S KW CK KD

You would get: Grade 2 Cylindrical Storeroom Lever, Pinnacle, Satin Chrome, 2 3/4" Deadlatch Square, ANSI 4 7/8" x 1 1/4" Strike, Kwikset Keyway, Construction Keyed, Keyed Different.



QCL200 series

Grade 2 Heavy Duty Cylindrical Levers

Pinnacle (PNN)

Pearce (PEA)

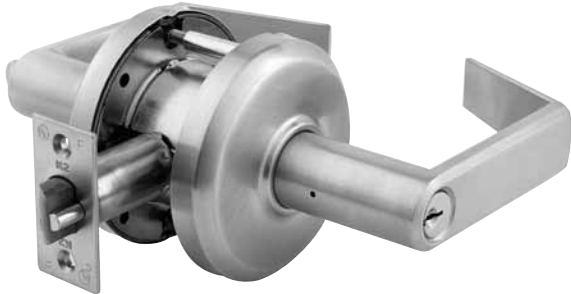

Available in: 605, 613, 619, 625, 626
 Privacy split available in: 626 x 625, 626 x 613*

Available in: 605, 613, 619, 625, 626
 Privacy split available in: 626 x 625, 626 x 613*

Model/Series	Functions	Style	Price		Case Quantity
			626	605, 613, 619, 625	
QCL220	Half Dummy	PNN / PEA	\$46.00	\$51.00	12
QCL230	Passage	PNN / PEA	\$97.00	\$107.00	6
QCL235	Communicating	PNN / PEA	\$102.00	\$112.00	6
QCL240*	Privacy	PNN / PEA	\$102.00	\$112.00	6
QCL250	Entrance/Office	PNN / PEA	\$122.00	\$132.00	6
QCL260	Classroom	PNN / PEA	\$122.00	\$132.00	6
QCL270	Storeroom	PNN / PEA	\$122.00	\$132.00	6

NOTES:





* Privacy split finishes are priced at the highest finish price.



QCL200 series

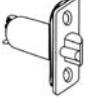

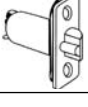

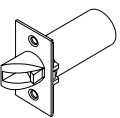
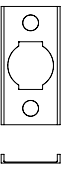
Grade 2 Heavy Duty Cylindrical Levers

LATCH OPTIONS (SPECIFY FINISH)

Order # With Lock	Description	Price With Lock	Service Part #	Service Part List Price	
1 1/8" X 2 1/4" FACE PLATE, 7/8" HOUSING DIAMETER, GRADE 2, UL (WIDE FACE)					
 Grade 2 - Deadlatch	234DS	2 3/4" dead latch - square corner	No Charge	8Q00187	\$6.50
	234DR	2 3/4" dead latch - radius corner	No Charge	8Q00186	\$6.50
	238DS	2 3/8" dead latch - square corner	No Charge	8Q00189	\$6.50
	238DR	2 3/8" dead latch - radius corner	No Charge	8Q00188	\$6.50
	334DS	3 3/4" dead latch - square corner	Add \$10.00	8Q00190	\$16.50
	500DS	5" dead latch - square corner	Add \$12.00	8Q00191	\$18.50
 Grade 2 - Springlatch	234SS	2 3/4" spring latch privacy - square corner	No Charge	8Q00193	\$6.50
		2 3/4" spring latch passage - square corner	No Charge	8Q00199	\$6.50
	234SR	2 3/4" spring latch privacy - radius corner	No Charge	8Q00192	\$6.50
		2 3/4" spring latch passage - radius corner	No Charge	8Q00198	\$6.50
	238SS	2 3/8" spring latch privacy - square corner	No Charge	8Q00195	\$6.50
		2 3/8" spring latch passage - square corner	No Charge	8Q00201	\$6.50
	238SR	2 3/8" spring latch privacy - radius corner	No Charge	8Q00194	\$6.50
		2 3/8" spring latch passage - radius corner	No Charge	8Q00200	\$6.50
	334SS	3 3/4" spring latch privacy - square corner	Add \$10.00	8Q00196	\$16.50
		3 3/4" spring latch passage - square corner	Add \$10.00	8Q00202	\$16.50
	500SS	5" spring latch privacy - square corner	Add \$12.00	8Q00197	\$18.50
		5" spring latch passage - square corner	Add \$12.00	8Q00203	\$18.50
1" X 2 1/4" FACE PLATE, 7/8" HOUSING DIAMETER, GRADE 2, UL (NARROW FACE)					
 Grade 2 - Deadlatch	234DSN	2 3/4" dead latch - square corner	No Charge	8Q00231	\$6.50
	234DRN	2 3/4" dead latch - radius corner	No Charge	8Q00230	\$6.50
	238DSN	2 3/8" dead latch - square corner	No Charge	8Q00233	\$6.50
	238DRN	2 3/8" dead latch - radius corner	No Charge	8Q00232	\$6.50
 Grade 2 - Springlatch	234SSN	2 3/4" spring latch privacy - square corner	No Charge	8Q00227	\$6.50
		2 3/4" spring latch passage - square corner	No Charge	8Q00223	\$6.50
	234SRN	2 3/4" spring latch privacy - radius corner	No Charge	8Q00226	\$6.50
		2 3/4" spring latch passage - radius corner	No Charge	8Q00222	\$6.50
	238SSN	2 3/8" spring latch privacy - square corner	No Charge	8Q00229	\$6.50
		2 3/8" spring latch passage - square corner	No Charge	8Q00225	\$6.50
	238SRN	2 3/8" spring latch privacy - radius corner	No Charge	8Q00228	\$6.50
		2 3/8" spring latch passage - radius corner	No Charge	8Q00224	\$6.50
1 1/8" X 2 1/4" FACE PLATE, 1" HOUSING DIAMETER, GRADE 1, 3/4" THROW, 3 HR UL					
	234DSF	2 3/4" dead latch, square corner, 3/4" throw	Add \$73.50	8Q00438	\$80.00
	234DRF	2 3/4" dead latch, radius corner, 3/4" throw	Add \$73.50	8Q00437	\$80.00
WIDE FACE LATCH FILLER					
		Wide face latch adaptor plate (converts 1" latch face plate to 1 1/8")	N/A	8Q00217	\$0.85
NO LATCH					
NOL	No Latch	Deduct \$6.50			



STRIKE OPTIONS (SPECIFY FINISH)

Order # With Lock	Description	Price With Lock	Service Part #	Service Part List Price
 118F	2 3/4" x 1 1/8" T-Strike	Deduct \$2.00	8Q00165	\$3.00
 478S	4 7/8" x 1 1/4" ANSI Strike	No Charge	8Q00166	\$5.00
 FLR	2 1/4" Full Lip Round Corner Strike UL	Deduct \$2.00	8Q00241	\$3.00
 FLS	2 1/4" Full Lip Square Corner Strike UL	Deduct \$2.00	8Q00240	\$3.00
NO STRIKE				
NOS	No Strike	Deduct \$5.00		



QCL200 series

Grade 2 Heavy Duty Cylindrical Levers

CYLINDER OPTIONS (SPECIFY FINISH)







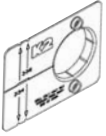
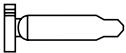
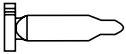

Order # With Lock	Description	Price With Lock	Service Part #	Service Part List Price
6-PIN BRASS CYLINDERS				
KW6	Kwikset KW - 6-Pin Entry/Storeroom Cylinder (KD)	No Charge	8Q00007	\$11.00
	Kwikset KW - 6-Pin Classroom Cylinder (KD)	No Charge	8Q00010	\$11.00
	Kwikset KW - 6-Pin Entry/Storeroom/Classroom Cylinder (ZB or Pinned)	No Charge	9Q0009-001	\$11.00
WE6	Weiser WE - 6-Pin Entry/Storeroom Cylinder (KD)	No Charge	8Q00008	\$11.00
	Weiser WE - 6-Pin Classroom Cylinder (KD)	No Charge	8Q00011	\$11.00
	Weiser WE - 6-Pin Entry/Storeroom/Storeroom Cylinder (ZB or Pinned)	No Charge	9Q0009-002	\$11.00
SC6	Schlage SC - 6-Pin Entry/Storeroom Cylinder (KD)	No Charge	8Q00009	\$11.00
	Schlage SC - 6-Pin Classroom Cylinder (KD)	No Charge	8Q00012	\$11.00
	Schlage SC - 6-Pin Entry/Storeroom/Classroom Cylinder (ZB or Pinned)	No Charge	9Q0009-003	\$11.00
GA6	Yale GA - 6-Pin Lever/Deadbolt Cylinder	No Charge	9Q0009-004	\$43.00
LA6	Sargent LA - 6-Pin Lever/Deadbolt Cylinder	No Charge	9Q0009-005	\$43.00
5-PIN BRASS CYLINDERS				
KW5	Kwikset KW - 5-Pin Entry/Storeroom/Classroom Cylinder (ZB or Pinned)	No Charge	9Q0009-006	\$11.00
WE5	Weiser WE - 5-Pin Entry/Storeroom/Storeroom Cylinder (ZB or Pinned)	No Charge	9Q0009-007	\$11.00
SC5	Schlage SC - 5-Pin Entry/Storeroom/Classroom Cylinder (ZB or Pinned)	No Charge	9Q0009-057	\$11.00
LESS CYLINDER				
LC	Less Cylinder	Deduct \$11		

* Consult factory for other cylinder options.

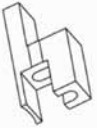
* Refer to cylinder, keys & keying section for keying charges and cylinder finishes.



OTHER PARTS & SCREW PACKS

Description	Service Part #	Service Part List Price
 Installation Jig for Cylindrical Levers	8Q00075	\$6.50
 Tailpiece QCL250/QCL270 - Entry/Storeroom	8Q00072	\$1.75
 Tailpiece QCL260 - Classroom	8Q00074	\$1.75
 SFIC Tailpiece for QCL200 Series	8Q00302	\$1.75
 Cylinder Plug Holder QCL200 Series	8Q00066	\$1.25
 Screw Pack & Tailpiece SFIC for QCL200 Series (Specify finish)	8Q00064	\$2.50
 Screw Pack for QCL200 Series Dummy (Specify finish)	8Q00059	\$1.25
 Screw Pack for QCL200 Series (Specify finish)	8Q00061	\$1.75
 Screw Pack for T-Strike (Specify finish)	8Q00058	\$1.25
 Trim Ring for Cylindrical Locks (Shims Lock off door approximately 1/8") (Available in 605, 613, 619, 626)	8Q00221	\$15.50



how to order: Interconnected Levers

K2 Products are simple to order. Our numbering system follows a logical progression that enables you to make sure you get exactly what you need, the first time. We don't over complicate things, we keep it simple ... just part of being the "Easiest to do Business with"

If you have a question, feel free to call one of our customer service representatives, they are ready to assist you...866-590-2094

Single Locking (Passage Lever)	30
Single Locking SFIC (Passage Lever)	31
Double Locking (Entry Lever)	50
Double Locking SFIC (Entry Lever)	51 [†]

605	Bright Brass
613	Oil Rubbed Bronze
619	Satin Nickel
626	Satin Chrome

SMT**	Smartkey available on QCI230 function only
KW*	Kwikset "KW"
WE*	Weiser "E"
SC*	Schlage "C"
GA	Yale "GA"
LA	Sargent "LA"
BF	SFIC "F"
LC	Less Cylinder

QC12	70	PNN	626	234DS	478S	KW	CK	XXXX
Series	Function	Design	Finish	Latch	Strike	Keyway	Keying	Notes

Grade 2 Interconnect	QC12xx
----------------------	--------

Pinnacle	PNN
Pearce	PEA

KD	Keyed Different
KA	Keyed Alike
CK	Construction Keyed
CMK	Construction Master Keyed
MAIS	Maison Keyed
MK	Master Keyed
GMK	Grand Master Keyed
GGMK	Great Grand Master Keyed
ZB	Zero Bitted

	Order with Lock	Lever Latch	Deadbolt Latch
QC1230/ 231	234BS	234SS	234BS
	234BR	234SR	234BR
	238BS	238SS	238BS
	238BR	238SR	234BR
	234BSN	234SSN	234BSN
	234BRN	234SRN	234BRN
	238BSN	238SSN	238BSN
	238BRN	238SRN	234BRN
QC1250/ 251	234BS	234DS	234BS
	234BR	234DR	234BR
	238BS	238DS	238BS
	238BR	238DR	234BR
	234BSN	234DSN	234BSN
	234BRN	234DRN	234BRN
	238BSN	238DSN	238BSN
	238BRN	238DRN	234BRN

Order with Lock	Lever Strike	Deadbolt Strike
118F	118F	DBS
478S	478S	DBS
FLS	FLS	DBS
FLR	FLR	DBR
FLS2	FLS	FLS
FLR2	FLR	FLR

* Available in 6-pin & 5-pin. 6-pin is standard.

** SMT - Smartkey available on QCI230 functions only.

† Consult factory for lead times.

Example

If you ordered: QC1230 PNN 626 234S 118F DBS KW KD

You would get: Grade 2 Interconnect Single Locking Leverset, Pinnacle, Satin Chrome, 2 3/4" Springlatch & Deadbolt Latches Square Corner, 1 1/8" "T" Strike with Standard Deadbolt Strike, Kwikset Keyway, Keyed Different.



QCI200 series

Grade 2 Heavy Duty Interconnected Leversets



Model/Series	Functions	Style	Price		Case Quantity
			626	605, 613, 619	
QCI230	Single Locking (passage lever)	PNN / PEA	\$229.00	\$239.00	6
QCI231	Single Locking SFIC (passage lever)	PNN / PEA	\$252.00	\$262.00	6
QCI250	Double Locking (entry lever)	PNN / PEA	\$250.00	\$260.00	6
QCI251*	Double Locking SFIC	PNN / PEA	\$294.00	\$304.00	6

NOTES:

* QCI251 Available at extended lead time. Consult factory.
 Smartkey Available on QCI230 Functions only.



QCI200 series

Grade 2 Heavy Duty Interconnected Leversets

LATCH COMBINATIONS (SPECIFY FINISH)



Order # With Lock	Lever Latch	Deadbolt Latch	Price With Lock	
QCI230/231	234BS	2 3/4" spring latch, square corner, 1 1/8" Face	2 3/4" bolt latch, square corner, 1 1/8" Face	No Charge
	234BR	2 3/4" spring latch, radius corner, 1 1/8" Face	2 3/4" bolt latch, radius corner, 1 1/8" Face	No Charge
	238BS	2 3/8" spring latch, square corner, 1 1/8" Face	2 3/8" bolt latch, square corner, 1 1/8" Face	No Charge
	238BR	2 3/8" spring latch, radius corner, 1 1/8" Face	2 3/8" bolt latch, radius corner, 1 1/8" Face	No Charge
	234BSN	2 3/4" spring latch, square corner, 1" Face	2 3/4" bolt latch, square corner, 1" Face	No Charge
	234BRN	2 3/4" spring latch, radius corner, 1" Face	2 3/4" bolt latch, radius corner, 1" Face	No Charge
	238BSN	2 3/8" spring latch, square corner, 1" Face	2 3/8" bolt latch, square corner, 1" Face	No Charge
	238BRN	2 3/8" spring latch, radius corner, 1" Face	2 3/8" bolt latch, radius corner, 1" Face	No Charge
QCI250/251	234BS	2 3/4" dead latch, square corner, 1 1/8" Face	2 3/4" bolt latch, square corner, 1 1/8" Face	No Charge
	234BR	2 3/4" dead latch, radius corner, 1 1/8" Face	2 3/4" bolt latch, radius corner, 1 1/8" Face	No Charge
	238BS	2 3/8" dead latch, square corner, 1 1/8" Face	2 3/8" bolt latch, square corner, 1 1/8" Face	No Charge
	238BR	2 3/8" dead latch, radius corner, 1 1/8" Face	2 3/8" bolt latch, radius corner, 1 1/8" Face	No Charge
	234BSN	2 3/4" dead latch, square corner, 1" Face	2 3/4" bolt latch, square corner, 1" Face	No Charge
	234BRN	2 3/4" dead latch, radius corner, 1" Face	2 3/4" bolt latch, radius corner, 1" Face	No Charge
	238BSN	2 3/8" dead latch, square corner, 1" Face	2 3/8" bolt latch, square corner, 1" Face	No Charge
	238BRN	2 3/8" dead latch, radius corner, 1" Face	2 3/8" bolt latch, radius corner, 1" Face	No Charge
NO LATCH				
NOL	No Latch (Lever & Deadbolt)		Deduct \$15.00	

LATCH OPTIONS (SPECIFY FINISH)

Order as parts only	Description	Service Part #	Service Part List Price	
	1 1/8" X 2 1/4" FACE PLATE, 7/8" HOUSING DIAMETER, GRADE 2, UL (WIDE FACE)			
	234SS	2 3/4" spring latch passage - square corner	8Q00199	\$6.50
	234SR	2 3/4" spring latch passage - radius corner	8Q00198	\$6.50
	238SS	2 3/8" spring latch passage - square corner	8Q00201	\$6.50
	238SR	2 3/8" spring latch passage - radius corner	8Q00200	\$6.50
	234DS	2 3/4" dead latch - square corner	8Q00187	\$6.50
	234DR	2 3/4" dead latch - radius corner	8Q00186	\$6.50
	238DS	2 3/8" dead latch - square corner	8Q00189	\$6.50
	238DR	2 3/8" dead latch - radius corner	8Q00188	\$6.50
	1" X 2 1/4" NARROW FACE PLATE, 7/8" HOUSING DIAMETER, GRADE 2, UL (NARROW FACE)			
	234SSN	2 3/4" spring latch passage - square corner	8Q00223	\$6.50
	234SRN	2 3/4" spring latch passage - radius corner	8Q00222	\$6.50
	238SSN	2 3/8" spring latch passage - square corner	8Q00225	\$6.50
	238SRN	2 3/8" spring latch passage - radius corner	8Q00224	\$6.50
	234DSN	2 3/4" dead latch - square corner	8Q00231	\$6.50
	234DRN	2 3/4" dead latch - radius corner	8Q00230	\$6.50
	238DSN	2 3/8" dead latch - square corner	8Q00233	\$6.50
	238DRN	2 3/8" dead latch - radius corner	8Q00232	\$6.50

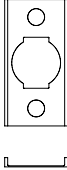

CONTINUED LATCH OPTIONS (SPECIFY FINISH)

Order as parts only	Description	Service Part #	Service Part List Price	
 <p>Grade 2 - Boltlatch</p>	DEADBOLT: 1 1/8" X 2 1/4" FACE PLATE, DEADBOLT, UL (WIDE FACE)			
	234BS	2 3/4" bolt latch - square corner	8Q00321	\$8.50
	234BR	2 3/4" bolt latch - radius corner	8Q00320	\$8.50
	238BS	2 3/8" bolt latch - square corner	8Q00319	\$8.50
	238BR	2 3/8" bolt latch - radius corner	8Q00318	\$8.50
 <p>Grade 2 - Boltlatch</p>	DEADBOLT: 1" X 2 1/4" FACE PLATE, DEADBOLT, UL (NARROW FACE)			
	234BSN	2 3/4" bolt latch - square corner	8Q00442	\$8.50
	234BRN	2 3/4" bolt latch - radius corner	8Q00441	\$8.50
	238BSN	2 3/8" bolt latch - square corner	8Q00440	\$8.50
	238BRN	2 3/8" bolt latch - radius corner	8Q00439	\$8.50
	WIDE FACE LATCH FILLER			
		Wide face latch adaptor plate (converts 1" latch face plate to 1 1/8")	8Q00217	\$0.85











QCI200 series

Grade 2 Heavy Duty Interconnected Leversets

STRIKE COMBINATIONS (SPECIFY FINISH)

Order # With Lock	Lever Latch	Deadbolt Latch	Price With Lock
118F	2 3/4" x 1 1/8" T-Strike	Standard Deadbolt Strike	No Charge
478S	ANSI 4 7/8" x 1 1/4" Strike	Standard Deadbolt Strike	Add \$2.00
FLS	Full Lip Square Corner Strike	Standard Deadbolt Strike-Square	No Charge
FLR	Full Lip Radius Corner Strike	Standard Deadbolt Strike-Radius	No Charge
FLS2	Full Lip Square Corner Strike	Full Lip Square Corner Strike	No Charge
FLR2	Full Lip Radius Corner Strike	Full Lip Radius Corner Strike	No Charge
NO STRIKE			
NOS	No Strike		Deduct \$6.00

STRIKE OPTIONS (SPECIFY FINISH)

Order as parts only	Description	Service Part #	Service Part List Price
LEVER			
	118F 2 3/4" x 1 1/8" T-Strike	8Q00165	\$3.00
	478S ANSI 4 7/8" x 1 1/4" Strike	8Q00166	\$5.00
	FLS Full Lip Square Corner Strike	8Q00240	\$3.00
	FLR Full Lip Radius Corner Strike	8Q00241	\$3.00
DEADBOLT			
	DBS 2 3/4" x 1 1/8" Deadbolt Strike-Square	8Q00164	\$3.00
	DBR 2 3/4" x 1 1/8" Deadbolt Strike-Radius	8Q00530	\$3.00
	478DS ANSI 4 7/8" x 1 1/4" Deadbolt Strike	8Q00244	\$5.00
	FLS 2 1/4" Full Lip Square Corner Deadbolt Strike	8Q00317	\$3.00
	FLR 2 1/4" Full Lip Radius Corner Deadbolt Strike	8Q00316	\$3.00



QCI200 series

Grade 2 Heavy Duty Interconnected Leversets

LEVER CYLINDER OPTIONS (SPECIFY FINISH)

Order # With Lock	Description	Price With Lock	Service Part #	Service Part List Price
6-PIN BRASS CYLINDERS				
KW6	Kwikset KW - 6-Pin Cylinder (KD)	No Charge	8Q00013	\$11.00
	Kwikset KW - 6-Pin Cylinder (ZB or Pinned)	No Charge	9Q0009-001	\$11.00
WE6	Weiser WE - 6-Pin Cylinder (KD)	No Charge	8Q00014	\$11.00
	Weiser WE - 6-Pin Cylinder (ZB or Pinned)	No Charge	9Q0009-002	\$11.00
SC6	Schlage SC - 6-Pin Cylinder (KD)	No Charge	8Q00015	\$11.00
	Schlage SC - 6-Pin Cylinder (ZB or Pinned)	No Charge	9Q0009-003	\$11.00
GA6	Yale GA - 6-Pin Lever/Deadbolt Cylinder	No Charge	9Q0009-004	\$43.00
LA6	Sargent LA - 6-Pin Lever/Deadbolt Cylinder	No Charge	9Q0009-005	\$43.00
BF6	SFIC BF- 6-Pin SFIC Cylinder	No Charge	8Q00036	\$34.00
5-PIN BRASS CYLINDERS				
KW5	Kwikset KW - 5-Pin Cylinder	No Charge	9Q0009-006	\$11.00
WE5	Weiser WE - 5-Pin Cylinder	No Charge	9Q0009-007	\$11.00
SC5	Schlage SC - 5-Pin Cylinder	No Charge	9Q0009-057	\$11.00
LESS CYLINDER				
LC	Less Cylinder	Deduct \$11		
	Less SFIC Cylinder	Deduct \$34		

* Consult factory for other cylinder options.

* Refer to cylinder, keys & keying section for keying charges and cylinder finishes.



QCI200 series

Grade 2 Heavy Duty Interconnected Leversets

DEADBOLT CYLINDER OPTIONS (SPECIFY FINISH)

Order # With Lock	Description	Price With Lock	Service Part #	Service Part List Price
6-PIN BRASS CYLINDERS				
KW6	Kwikset KW - 6-Pin Single Cylinder (KD)	No Charge	8Q00016	\$13.00
	Kwikset KW - 6-Pin Double Cylinder (KD)(QTY 1)	No Charge	8Q00019	\$12.00
	Kwikset KW - 6-Pin Deadbolt Cylinder (ZB or Pinned)	No Charge	9Q0009-050	\$13.00
WE6	Weiser WE - 6-Pin Single Cylinder (KD)	No Charge	8Q00017	\$13.00
	Weiser WE - 6-Pin Double Cylinder (KD)(QTY 1)	No Charge	8Q00020	\$13.00
	Weiser WE - 6-Pin Deadbolt Cylinder (ZB or Pinned)	No Charge	9Q0009-052	\$13.00
SC6	Schlage SC - 6-Pin Single Cylinder (KD)	No Charge	8Q00018	\$13.00
	Schlage SC - 6-Pin Double Cylinder (KD)(QTY 1)	No Charge	8Q00021	\$13.00
	Schlage SC - 6-Pin Deadbolt Cylinder (ZB or Pinned)	No Charge	9Q0009-054	\$13.00
GA6	Yale GA - 6-Pin Lever/Deadbolt Cylinder	No Charge	9Q0009-004	\$43.00
LA6	Sargent LA - 6-Pin Lever/Deadbolt	No Charge	9Q0009-005	\$43.00
BF6	SFIC BF- 6-Pin SFIC Single Cylinder	No Charge	8Q00037	\$34.00
	SFIC BF- 6-Pin SFIC Double Cylinder (QTY 1)	No Charge	8Q00038	\$34.00
5-PIN BRASS CYLINDERS				
KW5	Kwikset KW - 5-Pin Deadbolt Cylinder (ZB or Pinned)	No Charge	9Q0009-051	\$13.00
WE5	Weiser WE - 5-Pin Deadbolt Cylinder (ZB or Pinned)	No Charge	9Q0009-053	\$13.00
SC5	Schlage SC - 5-Pin Deadbolt Cylinder (ZB or Pinned)	No Charge	9Q0009-060	\$13.00
SMARTKEY CYLINDER				
SMT	Kwikset KW Smartkey Cylinder	No Charge	9Q0009-096	\$15.30
LESS CYLINDER				
LC	Less Cylinder	Deduct \$13		
	Less SFIC Cylinder	Deduct \$34		

* Consult factory for other cylinder options.

* Refer to cylinder, keys & keying section for keying charges and cylinder finishes.

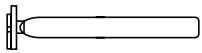
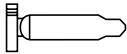
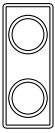

OTHER PARTS & SCREW PACKS

Description		Service Part #	Service Part List Price
	QCI200 Series deadbolt tailpiece	8Q00076	\$1.75
	Tailpiece QCI200 Series	8Q00072	\$1.75
	QCI200 Series outside escutcheon trim - 4' center to center (Specify finish)	8Q00303	\$15.50



how to order: Grade 2 Tubular Levers

K2 Products are simple to order. Our numbering system follows a logical progression that enables you to make sure you get exactly what you need, the first time. We don't over complicate things, we keep it simple ... just part of being the "Easiest to do Business with"

If you have a question, feel free to call one of our customer service representatives, they are ready to assist you...866-590-2094

Dummy Trim	20
Passage	30
Privacy	40
Entry/Office Lock	50
Entry/Office Lock (SFIC)	51
Classroom Lock	60
Classroom Lock (SFIC)	61
Storeroom Lock	70
Storeroom Lock (SFIC)	71

605	Bright Brass
613	Oil Rubbed Bronze
619	Satin Nickel
625	Bright Chrome
626	Satin Chrome
626x625	Satin Chrome x Bright Chrome (Privacy Only)

KW*	Kwikset "KW"
WE*	Weiser "E"
SC*	Schlage "C"
GA	Yale "GA"
LA	Sargent "LA"
BF	SFIC "F"
LC	Less Cylinder

QTL2	60	NOR	625	ADLS	FLR	KW	KD	XXXX
Series	Function	Design	Finish	Latch*	Strike	Keyway	Keying	Notes

Grade 2 Tubular	QTL2xx
-----------------	--------

Nordic	NOR
Essex	ESX

Adjustable Backset Deadlatch Square	ADLS
Adjustable Backset Deadlatch Radius	ADLR
Adjustable Backset Springlatch Square	ASLS
Adjustable Backset Springlatch Radius	ASLR

KD	Keyed Different
KA	Keyed Alike
CK	Construction Keyed
CMK	Construction Master Keyed
MAIS	Maison Keyed
MK	Master Keyed
GMK	Grand Master Keyed
GGMK	Great Grand Master Keyed
ZB	Zero Bitted

478S	ANSI 4 7/8" x 1 1/4" Strike
118F	1 1/8" x 2 3/4" T-Strike
FLS	Full Lip Square Corner Strike
FLR	Full Lip 1/4" Radius Corner Strike

* 1 1/8" latch face adapter plate also available in service parts
* Available in 6-pin & 5-pin. 6-pin is standard.

Example

If you ordered: QTL260 NOR 625 ADLS FLR KW KA

You would get: Grade 2 Tubular Classroom Lever, Nordic, Bright Chrome, Adjustable Deadlatch Square face, Full Lip 1/4" Radius Strike, Kwikset keyway, Keyed Alike



QTL200 series

Grade 2 Standard Duty Tubular Levers

Nordic (NOR)

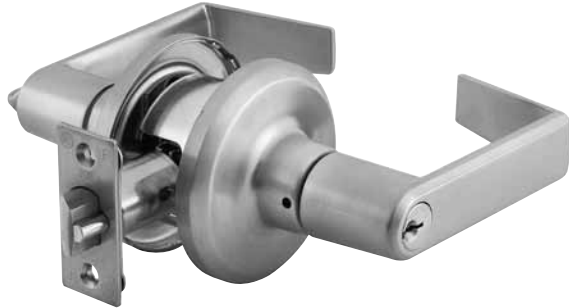

Available in: 605, 613, 619, 625, 626
 Privacy split available in: 626 x 625*

Essex (ESX)



Available in: 605, 613, 619, 625, 626
 Privacy split available in: 626 x 625*



Model/Series	Functions	Style	Price		Case Quantity
			626	605, 613, 619, 625	
QTL220	Half Dummy	NOR / ESX	\$36.00	\$38.00	12
QTL230	Passage	NOR / ESX	\$73.00	\$75.00	10
QTL240*	Privacy	NOR / ESX	\$78.00	\$80.00	10
QTL250	Entry/Office	NOR / ESX	\$88.00	\$90.00	10
QTL251	Entry/Office SFIC	NOR / ESX	\$111.00	\$113.00	10
QTL260	Classroom	NOR / ESX	\$88.00	\$90.00	10
QTL261	Classroom SFIC	NOR / ESX	\$111.00	\$113.00	10
QTL270	Storeroom	NOR / ESX	\$88.00	\$90.00	10
QTL271	Storeroom SFIC	NOR / ESX	\$111.00	\$113.00	10

NOTES:

* Privacy split finishes are priced at the highest finish price.



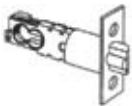

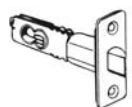
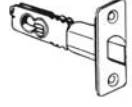
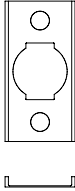
LATCH OPTIONS (SPECIFY FINISH)

Order # With Lock	Description	Price With Lock	Service Part #	Service Part List Price	
1" X 2 1/4" FACE PLATE, GRADE 2 TUBULAR, UL (NARROW FACE)					
	ADLS	Adjustable tubular dead latch, 1" square corner face plate G2 UL	No Charge	8Q00162	\$6.50
	ADLR	Adjustable tubular dead latch, 1" radius corner face plate G2 UL	No Charge	8Q00204	\$6.50
	ASLS	Adjustable tubular spring latch, 1" square corner face plate G2 UL	No Charge	8Q00163	\$6.50
	ASLR	Adjustable tubular spring latch, 1" radius corner face plate G2 UL	No Charge	8Q00205	\$6.50
WIDE FACE LATCH FILLER					
		Wide face latch adaptor plate (converts 1" latch face plate to 1 1/8")	N/A	8Q00217	\$0.85
NO LATCH					
NOL	No Latch	Deduct \$6.50			

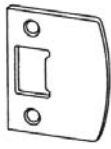

STRIKE OPTIONS (SPECIFY FINISH)

Order # With Lock		Description	Price With Lock	Service Part #	Service Part List Price
	118F	2 3/4" x 1 1/8" T-Strike	No Charge	8Q00165	\$3.00
	478S	4 7/8" x 1 1/4" ANSI Strike	Add \$2.00	8Q00166	\$5.00
	FLR	2 1/4" Full Lip Round Corner Strike UL	No Charge	8Q00241	\$3.00
	FLS	2 1/4" Full Lip Square Corner Strike UL	No Charge	8Q00240	\$3.00
NO STRIKE					
NOS		No Strike	Deduct \$3.00		



QTL200 series

Grade 2 Standard Duty Tubular Levers

CYLINDER OPTIONS (SPECIFY FINISH)







Order # With Lock	Description	Price With Lock	Service Part #	Service Part List Price
6-PIN BRASS CYLINDERS				
KW6	Kwikset KW - 6-Pin Entry/Storeroom/Classroom Cylinder (KD)	No Charge	8Q00013	\$11.00
	Kwikset KW - 6-Pin Entry/Storeroom/Classroom Cylinder (ZB or Pinned)	No Charge	9Q0009-001	\$11.00
WE6	Weiser WE - 6-Pin Entry/Storeroom/Classroom Cylinder (KD)	No Charge	8Q00014	\$11.00
	Weiser WE - 6-Pin Entry/Storeroom/Storeroom Cylinder (ZB or Pinned)	No Charge	9Q0009-002	\$11.00
SC6	Schlage SC - 6-Pin Entry/Storeroom/Classroom Cylinder (KD)	No Charge	8Q00015	\$11.00
	Schlage SC - 6-Pin Entry/Storeroom/Classroom Cylinder (ZB or Pinned)	No Charge	9Q0009-003	\$11.00
GA6	Yale GA - 6-Pin Lever/Deadbolt Cylinder	No Charge	9Q0009-004	\$43.00
LA6	Sargent LA - 6-Pin Lever/Deadbolt Cylinder	No Charge	9Q0009-005	\$43.00
BF6	SFIC BF- 6-Pin SFIC Cylinder	No Charge	8Q00036	\$34.00
5-PIN BRASS CYLINDERS				
KW5	Kwikset KW - 5-Pin Entry/Storeroom/Classroom Cylinder (ZB or Pinned)	No Charge	9Q0009-006	\$11.00
WE5	Weiser WE - 5-Pin Entry/Storeroom/Storeroom Cylinder (ZB or Pinned)	No Charge	9Q0009-007	\$11.00
SC5	Schlage SC - 5-Pin Entry/Storeroom/Classroom Cylinder (ZB or Pinned)	No Charge	9Q0009-057	\$11.00
LESS CYLINDER				
LC	Less Cylinder	Deduct \$11		
	Less SFIC Cylinder	Deduct \$34		

* Consult factory for other cylinder options.

* Refer to cylinder, keys & keying section for keying charges and cylinder finishes.



OTHER PARTS & SCREW PACKS

Description		Service Part #	Service Part List Price
	Tailpiece QTL200 & QRT300 Series	8Q00073	\$1.75
	Cylinder Plug Holder QTL200 Series - Essex Style	8Q00067	\$1.25
	Cylinder Plug Holder QTL200 Series - Nordic Style	8Q00068	\$1.25
	Screw Pack for QTL200 Series (Specify Finish)	8Q00062	\$1.25
	Screw Pack for T-Strike (Specify Finish)	8Q00058	\$1.25
	Thick Door Pack for QTL200 Series (1 $\frac{3}{4}$ " - 2") (Specify Finish)	8Q00063	\$1.25



QDB100 series

Grade 1 Auxiliary Deadbolts

Single Cylinder



Available in: 605, 613, 619, 625, 626

Double Cylinder



Available in: 605, 613, 619, 625, 626



Model/Series	Functions	Price		Case Quantity
		626	605, 613, 619, 625	
QDB180	Single Cylinder	\$96.00	\$101.00	12
QDB181	Single Cylinder SFIC	\$117.00	\$122.00	12
QDB182	Double Cylinder	\$123.00	\$128.00	12
QDB183	Double Cylinder SFIC	\$165.00	\$170.00	12
QDB186*	Classroom	\$100.00	\$105.00	12
QDB187*	Classroom SFIC	\$121.00	\$126.00	12

NOTES:

* Classroom deadbolts available in 626 finish at standard lead times. Consult factory for lead times on alternative finishes.





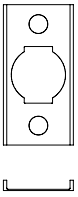

LATCH OPTIONS (SPECIFY FINISH)

Order # With Lock	Description	Price With Lock	Service Part #	Service Part List Price	
1 1/8" X 2 1/4" FACE PLATE, DEADBOLT, UL (WIDE FACE)					
	234BS	2 3/4" bolt latch - square corner	No Charge	8Q00170	\$8.50
	234BR	2 3/4" bolt latch - radius corner	No Charge	8Q00169	\$8.50
	238BS	2 3/8" bolt latch - square corner	No Charge	8Q00168	\$8.50
	238BR	2 3/8" bolt latch - radius corner	No Charge	8Q00167	\$8.50
1" X 2 1/4" FACE PLATE, DEADBOLT, UL (NARROW FACE)					
	234BSN	2 3/4" bolt latch - square corner	No Charge	8Q00237	\$8.50
	234BRN	2 3/4" bolt latch - radius corner	No Charge	8Q00236	\$8.50
	238BSN	2 3/8" bolt latch - square corner	No Charge	8Q00235	\$8.50
	238BRN	2 3/8" bolt latch - radius corner	No Charge	8Q00234	\$8.50
WIDE FACE LATCH FILLER					
		Wide face latch adaptor plate (converts 1" latch face plate to 1 1/8")		8Q00217	\$0.85
NO LATCH					
NOL	No Latch	Deduct \$8.50			

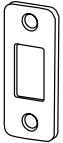

STRIKE OPTIONS (SPECIFY FINISH)

Order # With Lock	Description	Price With Lock	Service Part #	Service Part List Price
 DBS	2 3/4" x 1 1/8" Standard Square Deadbolt Strike and Reinforcer	No Charge	8Q00164	\$3.00
 DBR	2 3/4" x 1 1/8" Standard Radius Deadbolt Strike and Reinforcer	No Charge	8Q00530	\$3.00
 478S	4 7/8" x 1 1/4" ANSI Strike	Add \$2.00	8Q00244	\$5.00
 FLR	2 1/4" Full Lip Round Corner Strike UL	No Charge	8Q00316	\$3.00
 FLS	2 1/4" Full Lip Square Corner Strike UL	No Charge	8Q00317	\$3.00
	Plastic Strike Box for QDB100 & QDB200 Series (DBS Strike only)	N/A	8Q00161	\$1.75
NO STRIKE				
NOS	No Strike	Deduct \$3.00		



QDB100 series

Grade 1 Auxiliary Deadbolts

CYLINDER OPTIONS (SPECIFY FINISH)

Order # With Lock	Description	Price With Lock	Service Part #	Service Part List Price
6-PIN BRASS CYLINDERS				
KW6	Kwikset KW - 6-Pin Single Cylinder (KD)	No Charge	8Q00016	\$13.00
	Kwikset KW - 6-Pin Double Cylinder (KD) (QTY 1)	No Charge	8Q00019	\$13.00
	Kwikset KW - 6-Pin Deadbolt Cylinder (ZB or Pinned)	No Charge	9Q0009-050	\$13.00
WE6	Weiser WE - 6-Pin Single Cylinder (KD)	No Charge	8Q00017	\$13.00
	Weiser WE - 6-Pin Double Cylinder (KD) (QTY 1)	No Charge	8Q00020	\$13.00
	Weiser WE - 6-Pin Deadbolt Cylinder (ZB or Pinned)	No Charge	9Q0009-052	\$13.00
SC6	Schlage SC - 6-Pin Single Cylinder (KD)	No Charge	8Q00018	\$13.00
	Schlage SC - 6-Pin Double Cylinder (KD) (QTY 1)	No Charge	8Q00021	\$13.00
	Schlage SC - 6-Pin Deadbolt Cylinder (ZB or Pinned)	No Charge	9Q0009-054	\$13.00
GA6	Yale GA - 6-Pin Lever/Deadbolt Cylinder	No Charge	9Q0009-004	\$43.00
LA6	Sargent LA - 6-Pin Lever/Deadbolt	No Charge	9Q0009-005	\$43.00
BF6	SFIC BF- 6-Pin SFIC Single Cylinder	No Charge	8Q00037	\$34.00
	SFIC BF- 6-Pin SFIC Double Cylinder (QTY 1)	No Charge	8Q00038	\$34.00
5-PIN BRASS CYLINDERS				
KW5	Kwikset KW - 5-Pin Deadbolt Cylinder (ZB or Pinned)	No Charge	9Q0009-051	\$13.00
WE5	Weiser WE - 5-Pin Deadbolt Cylinder (ZB or Pinned)	No Charge	9Q0009-053	\$13.00
SC5	Schlage SC - 5-Pin Deadbolt Cylinder (ZB or Pinned)	No Charge	9Q0009-060	\$13.00
LESS CYLINDER				
LC	Less Cylinder	Deduct \$13		
	Less SFIC Cylinder	Deduct \$34		

* Consult factory for other cylinder options.









* Refer to cylinder, keys & keying section for keying charges and cylinder finishes.

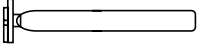

QDB100 series

Grade 1 Auxiliary Deadbolts

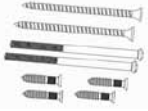
OTHER PARTS & SCREW PACKS

Description	Service Part #	Service Part List Price
 Tailpiece for QDB100 & QDB200 Series Double Cylinder (Qty 2)	8Q00085	\$1.75
 Tailpiece and washer for Single Cylinder QDB100 & QDB200 Series	8Q00083	\$1.75
 Spacer for Double Cylinder Deadbolt SFIC QDB100 & QDB200 Series (Specify finish)	8Q00082	\$1.75
 Thick Door Pack for QDB100 Series Single Cylinder (1 3/4" - 2 1/4") (Specify finish)	8Q00077	\$1.75
 Thick Door Pack for QDB100 & QDB200 Series Double Cylinder (1 3/4" - 2 1/4") (Specify finish)	8Q00079	\$1.75
 Thick Door Kit - Tailpiece and washer for Single Cylinder QDB100 & QDB200 Series (1 3/4" - 2 1/4")	8Q00084	\$1.75
 Cylinder Screw QDB100 & QDB200 Series	8Q00086	\$1.75
 Screw Pack for T-Strike (Specify finish)	8Q00058	\$1.25
 Screw Pack for QDB100 Series Single Cylinder (Specify finish)	8Q00076	\$1.75
 Screw Pack for QDB100 & QDB200 Series Double Cylinder (Specify finish)	8Q00078	\$1.75



how to order: Auxiliary Deadbolts

K2 Products are simple to order. Our numbering system follows a logical progression that enables you to make sure you get exactly what you need, the first time. We don't over complicate things, we keep it simple ...just part of being the "Easiest to do Business with"

If you have a question, feel free to call one of our customer service representatives, they are ready to assist you...866-590-2094

Single Cylinder	80
Single Cylinder (SFIC)	81
Double Cylinder	82
Double Cylinder (SFIC)	83
Inside Turnbolt Only	84
Indicator	85
Classroom	86
Classroom (SFIC)	87
Key Control†	88

605	Bright Brass
613	Oil Rubbed Bronze
619	Satin Nickel
625	Bright Chrome
626	Satin Chrome

SMT	Kwikset "KW" SmartKey
KW*	Kwikset "KW"
WE*	Weiser "E"
SC*	Schlage "C"
GA	Yale "GA"
LA	Sargent "LA"
BF	SFIC "F"
LC	Less Cylinder

QDB2	82	626	238BS	DBS	WE	KD	XXXX
Series	Function	Finish	Latch	Strike	Keyway	Keying	Notes

Grade 2 Auxiliary Deadbolt	QDB2xx
----------------------------	--------

2 3/4" Deadbolt Latch Square - 1 1/8" Face	234BS
2 3/4" Deadbolt Latch Radius - 1 1/8" Face	234BR
2 3/8" Deadbolt Latch Square - 1 1/8" Face	238BS
2 3/8" Deadbolt Latch Radius - 1 1/8" Face	238BR
2 3/4" bolt latch - square corner - 1" Face	234BSN
2 3/4" bolt latch - radius corner - 1" Face	234BRN
2 3/8" bolt latch - square corner - 1" Face	238BSN
2 3/8" bolt latch - radius corner - 1" Face	238BRN
6 Way adjustable Latch	6WAL
QDB288 Square Corner	SCAL
QDB288 Round Corner	RCAL

KD	Keyed Different
KA	Keyed Alike
CK	Construction Keyed
CMK	Construction Master Keyed
MAIS	Maison Keyed
MK	Master Keyed
GMK	Grand Master Keyed
GGMK	Great Grand Master Keyed
ZB	Zero Bitted

478S	ANSI 4 7/8" x 1 1/4" Strike
FLS	Full Lip Square Corner Strike
FLR	Full Lip 1/4" Radius Corner Strike
DBS	Standard Deadbolt Strike 1 1/8" x 2 3/4" - Square
DBR	Standard Deadbolt Strike 1 1/8" x 2 3/4" - Radius

* Available in 6-pin & 5-pin. 6-pin is standard.

† Key Control Deadbolt only available with Smartkey Cylinders.

Example

If you ordered: QDB282 626 238BS DBS WE KD

You would get: Grade 2 Double Cylinder Auxiliary Deadbolt, Satin Chrome, 2 3/8" Deadbolt Latch Square, Standard Deadbolt Strike, Weiser Keyway, Keyed Different



QDB200 series

Grade 2 Auxiliary Deadbolts

Single Cylinder



Available in: 605, 613, 619, 625, 626

Double Cylinder



Available in: 605, 613, 619, 625, 626

QDB285 Indicator



Available in: 605, 613, 619, 625, 626*

QDB288 Key Control



Available in: 605, 619, 626

Model/Series	Functions	Price		Case Quantity
		626	605, 613, 619, 625	
QDB280	Single Cylinder	\$61.00	\$64.00	12
QDB281	Single Cylinder SFIC	\$82.00	\$85.00	12
QDB282	Double Cylinder	\$77.00	\$80.00	12
QDB283	Double Cylinder SFIC	\$119.00	\$122.00	12
QDB284	Inside Turnbolt	\$29.00	\$32.00	20
QDB285*	Indicator	\$48.00	\$51.00*	12
QDB286*	Classroom	\$64.00	\$67.00*	12
QDB287*	Classroom SFIC	\$85.00	\$88.00*	12
QDB288†	Key Control	\$72.00	\$75.00	12

NOTES:

* Classroom and indicator deadbolts available in 626 finish at standard lead times. Consult factory for lead times on alternative finishes.



† Key Control Deadbolt available with Smartkey Cylinders only.



QDB200 series



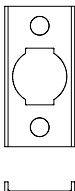

Grade 2 Auxiliary Deadbolts

LATCH OPTIONS (SPECIFY FINISH)

Order # With Lock	Description	Price With Lock	Service Part #	Service Part List Price	
1 1/8" X 2 1/4" FACE PLATE, DEADBOLT, UL (WIDE FACE)					
	234BS	2 3/4" bolt latch - square corner	No Charge	8Q00170	\$8.50
	234BR	2 3/4" bolt latch - radius corner	No Charge	8Q00169	\$8.50
	238BS	2 3/8" bolt latch - square corner	No Charge	8Q00168	\$8.50
	238BR	2 3/8" bolt latch - radius corner	No Charge	8Q00167	\$8.50
1" X 2 1/4" FACE PLATE, DEADBOLT, UL (NARROW FACE)					
	234BSN	2 3/4" bolt latch - square corner	No Charge	8Q00237	\$8.50
	234BRN	2 3/4" bolt latch - radius corner	No Charge	8Q00236	\$8.50
	238BSN	2 3/8" bolt latch - square corner	No Charge	8Q00235	\$8.50
	238BRN	2 3/8" bolt latch - radius corner	No Charge	8Q00234	\$8.50
6 WAY ADJUSTABLE LATCHES, DEADBOLT, UL (NARROW)					
6WAL	1" square corner, 1" round corner and drive-in	\$2.00	8Q00482	\$10.50	
QDB288 KEY CONTROL LATCHES, 1" X 2 1/4" FACE PLATE, ADJUSTABLE BACKSET, UL					
	SCAL	Square corner adjustable latch	No Charge	8Q00451	\$8.50
	RCAL	Round corner adjustable latch	No Charge	8Q00450	\$8.50
WIDE FACE LATCH FILLER					
	Wide face latch adaptor plate (converts 1" latch face plate to 1 1/8")	N/A	8Q00217	\$0.85	
NO LATCH					
NOL	No Latch	Deduct \$8.50			

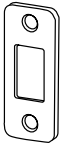

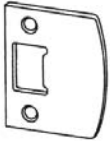
STRIKE OPTIONS (SPECIFY FINISH)

Order # With Lock	Description	Price With Lock	Service Part #	Service Part List Price
 DBS	2 3/4" x 1 1/8" Standard Square Deadbolt Strike and Reinforcer	No Charge	8Q00164	\$3.00
 DBR	2 3/4" x 1 1/8" Standard Radius Deadbolt Strike and Reinforcer	Add \$2.00	8Q00530	\$3.00
 478S	4 7/8" x 1 1/4" ANSI Strike	Add \$2.00	8Q00244	\$5.00
 FLR	2 1/4" Full Lip Round Corner Strike UL	No Charge	8Q00316	\$3.00
 FLS	2 1/4" Full Lip Square Corner Strike UL	No Charge	8Q00317	\$3.00
	Plastic Strike Box for QDB100 & QDB200 Series (DBS Strike only)	N/A	8Q00161	\$1.75
NO STRIKE				
NOS	No Strike	Deduct \$3.00		



CYLINDER OPTIONS (SPECIFY FINISH)

Order # With Lock	Description	Price With Lock	Service Part #	Service Part List Price
6-PIN BRASS CYLINDERS				
KW6	Kwikset KW - 6-Pin Single Cylinder (KD)	No Charge	8Q00016	\$13.00
	Kwikset KW - 6-Pin Double Cylinder (KD) (QTY 1)	No Charge	8Q00019	\$13.00
	Kwikset KW - 6-Pin Deadbolt Cylinder (ZB or Pinned)	No Charge	9Q0009-050	\$13.00
WE6	Weiser WE - 6-Pin Single Cylinder (KD)	No Charge	8Q00017	\$13.00
	Weiser WE - 6-Pin Double Cylinder (KD) (QTY 1)	No Charge	8Q00020	\$13.00
	Weiser WE - 6-Pin Deadbolt Cylinder (ZB or Pinned)	No Charge	9Q0009-052	\$13.00
SC6	Schlage SC - 6-Pin Single Cylinder (KD)	No Charge	8Q00018	\$13.00
	Schlage SC - 6-Pin Double Cylinder (KD) (QTY 1)	No Charge	8Q00021	\$13.00
	Schlage SC - 6-Pin Deadbolt Cylinder (ZB or Pinned)	No Charge	9Q0009-054	\$13.00
GA6	Yale GA - 6-Pin Lever/Deadbolt Cylinder	No Charge	9Q0009-004	\$43.00
LA6	Sargent LA - 6-Pin Lever/Deadbolt	No Charge	9Q0009-005	\$43.00
BF6	SFIC BF- 6-Pin SFIC Single Cylinder	No Charge	8Q00037	\$34.00
	SFIC BF- 6-Pin SFIC Double Cylinder (QTY 1)	No Charge	8Q00038	\$34.00
5-PIN BRASS CYLINDERS				
KW5	Kwikset KW - 5-Pin Deadbolt Cylinder (ZB or Pinned)	No Charge	9Q0009-051	\$13.00
WE5	Weiser WE - 5-Pin Deadbolt Cylinder (ZB or Pinned)	No Charge	9Q0009-053	\$13.00
SC5	Schlage SC - 5-Pin Deadbolt Cylinder (ZB or Pinned)	No Charge	9Q0009-060	\$13.00

* Consult factory for other cylinder options.

* Refer to cylinder, keys & keying section for keying charges and cylinder finishes.



QDB200 series

Grade 2 Auxiliary Deadbolts

CYLINDER OPTIONS (SPECIFY FINISH)









Order # With Lock	Description	Price With Lock	Service Part #	Service Part List Price
SMARTKEY CYLINDERS				
SMT	Kwikset Smartkey Cylinder - QDB280	No Charge	9Q0009-096	\$15.30
	Kwikset Smartkey Cylinder - QDB288 Tenant Cylinder (Bottom)	No Charge	9Q0009-117	\$15.30
	Kwikset Smartkey Cylinder - QDB288 Control Cylinder (Top)	No Charge	9Q0009-098	\$15.30
LESS CYLINDER				
LC	Less Cylinder	Deduct \$13		
	Less SFIC Cylinder	Deduct \$34		

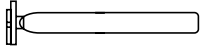

QDB200 series







Grade 2 Auxiliary Deadbolts

OTHER PARTS & SCREW PACKS

Description		Service Part #	Service Part List Price
	Tailpiece for QDB100 & QDB200 Series Double Cylinder (Qty 2)	8Q00085	\$1.75
	Tailpiece and washer for Single Cylinder QDB100 & QDB200 Series	8Q00083	\$1.75
	Spacer for Double Cylinder Deadbolt SFIC QDB100 & QDB200 Series (Specify finish)	8Q00082	\$1.75
	Thick Door Pack for QDB200 Series Single Cylinder (1 3/4" - 2 1/4") (Specify finish)	8Q00081	\$1.75
	Thick Door Pack for QDB100 & QDB200 Series Double Cylinder (1 3/4" - 2 1/4") (Specify finish)	8Q00079	\$1.75
	Thick Door Kit - Tailpiece and washer for Single Cylinder (1 3/4" - 2 1/4")	8Q00084	\$1.40
	Cylinder Screw QDB100 & QDB200 Series	8Q00086	\$1.75
	Screw Pack for T-Strike (Specify finish)	8Q00058	\$1.25
	Screw Pack for QDB200 Series Single Cylinder (Specify finish)	8Q00080	\$1.75
	Screw Pack for QDB100 & QDB200 Series Double Cylinder (Specify finish)	8Q00078	\$1.75



OTHER PARTS & SCREW PACKS

Description		Service Part #	Service Part List Price
	Cylinder Cover for QDB288 Key Control	8Q00453	\$2.00
	Mounting screws for QDB288 Key Control	8Q00477	\$1.40
	Torque blade for QDB288 Key Control	8Q00476	\$1.30
	Gear assembly for QDB288 Key Control	8Q00474	\$5.00
	Screws for gear assembly for QDB288 Key Control	8Q00475	\$1.00
	Reset Cradle for SmartKey cylinders	8Q00484	\$34.00
	QDB288 Key Control Rotation Tool	8Q00523	\$3.00



K2 Products are simple to order. Our numbering system follows a logical progression that enables you to make sure you get exactly what you need, the first time. We don't over complicate things, we keep it simple ... just part of being the "Easiest to do Business with"

If you have a question, feel free to call one of our customer service representatives, they are ready to assist you...866-590-2094

Rim Hex Dog	11
Rim Cylinder Dog	12
Rim Fire Rated	13
SVR - Hex Dog	14
SVR - Cylinder Dog	15
SVR - Fire Rated	16
SVR - LBR - Hex Dog	17
SVR - LBR - Cylinder Dog	18
SVR - LBR - Fire Rated	19

CVR - Hex Dog	24
CVR - Cylinder Dog	25
CVR - Fire Rated	26
CVR - LBR - Hex Dog	27
CVR - LBR - Cylinder Dog	28
CVR - LBR - Fire Rated	29

KW*	Kwikset "KW"
WE*	Weiser "E"
SC*	Schlage "C"
GA	Yale "GA"
LA	Sargent "LA"
BF	SFIC "F"
LC	Less Cylinder

QED1	15	LR	36"	7FT	313AN	KW	KD	XXXX
Series	Function	Electrification	Size	Trim*	Finish	Keyway**	Keying**	Notes

Grade 1 Architectural Exit Device	QED1xx
-----------------------------------	---------------

36	36" Device	7 ft Rod	7FT
48	48" Device†	8 ft Rod	8FT

KD	Keyed Different
KA	Keyed Alike
CK	Construction Keyed
CMK	Construction Master Keyed
MAIS	Maison Keyed
MK	Master Keyed
GMK	Grand Master Keyed
GGMK	Great Grand Master Keyed
ZB	Zero Bitted

Electrified latch retraction	LR
Electrified latch retraction with request to exit	LRX
Electrified dogging	ED
Electrified dogging with request to exit	EDX
Request to exit	X

Bright Brass	605†
Anodized DuraNotic Bronze	313AN
Brushed Chrome	626

* Applies to Surface Vertical Rods only

** Applies to Cylinder Dogged only

* Available in 6-pin & 5-pin. 6-pin is standard.

† Consult factory for lead times.

Example

If you ordered: QED115 36" 7FT 313AN KW KD

You would get: Grade 1 Heavy Duty Architectural Surface Vertical Rod Exit Device with Cylinder Dogging for a 7 Foot Door, in Anodized DuraNotic Bronze finish. Kwikset Keyway, Keyed Different.



Architectural Exit Device

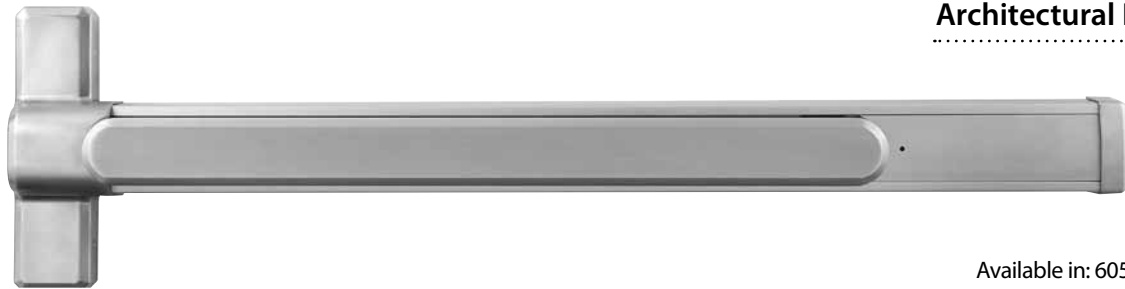

Available in: 605†, 313AN, 626

Model/Series	Functions	Style	List Price		Case Quantity
			626	605†, 313AN	
QED111	Rim - Hex Dog		\$675.00	\$705.00	1
QED112*	Rim - Cylinder Dog		\$675.00	\$705.00	1
QED113	Rim - Fire Rated		\$725.00	\$755.00	1
QED114	SVR - Hex Dog	7FT	\$890.00	\$920.00	1
QED115*	SVR - Cylinder Dog	7FT	\$890.00	\$920.00	1
QED116	SVR - Fire Rated	7FT	\$940.00	\$970.00	1
QED117	SVR Less Bottom Rod - Hex Dog	7FT	\$865.00	\$895.00	1
QED118*	SVR Less Bottom Rod - Cylinder Dog	7FT	\$865.00	\$895.00	1
QED119	SVR Less Bottom Rod - Fire Rated	7FT	\$915.00	\$945.00	1
QED124	CVR - Hex Dog	7FT	\$940.00	\$970.00	1
QED125*	CVR - Cylinder Dog	7FT	\$940.00	\$970.00	1
QED126	CVR - Fire Rated	7FT	\$990.00	\$1020.00	1
QED127	CVR - LBR - Hex Dog	7FT	\$920.00	\$950.00	1
QED128*	CVR - LBR - Cylinder Dog	7FT	\$920.00	\$950.00	1
QED129	CVR - LBR - Fire Rated	7FT	\$970.00	\$1000.00	1

NOTES:

- †CONSULT FACTORY FOR LEAD-TIME ON 605 FINISH.
- *CYLINDERS ORDERED SEPARATELY.
- CYLINDER OPTIONS AND PRICING ON PAGE K-6.
- ALL LBR FIRE RATED DEVICES INCLUDE A BOTTOM FIRE LATCH.

Options

8FT	Vertical rod kit for 8FT door application	Add \$25.00
48"	48" Device (Consult factory for lead-time)	Add \$30.00



QED100 series

Grade 1 Extra Heavy Duty Architectural Exit Devices

ELECTRIFIED OPTIONS (CONSULT FACTORY FOR LEAD TIMES)



Model #	Description	List Price Adder
QED__LR	Electrified Latch Retraction (LR) allows for the remote unlatching of exit devices. Continuous duty solenoids retract latches momentarily or for extended periods of time. <i>Requires</i> the use of K2 power supply 8Q00312 or 8Q00313.	\$695.00
QED__ED	Electrified Dogging (ED) allows continuous latch retraction and dogging simultaneously. ED requires first time mechanical activation after which the push bar will continuously hold the push bar and latch retracted. When power is removed or interrupted from the device, the latch bolt will extend and push bar will release. Uses power supply 8Q00314 (on page D-5)	\$595.00
QED__X	Request to Exit (X) is an SPDT (Single Pole Double Throw) switch which monitors the push bar of the exit device. The X switch can be used to activate a door alarm, control a magnetic locking device, shunt a door alarm or signal a control console when the push bar is depressed.	\$215.00
QED__LRX	Electrified Latch Retraction (LR) device with a Request to Exit (X) switch. <i>Requires</i> the use of K2 power supply 8Q00312 or 8Q00313.	\$850.00
QED__EDX	Electrified Dogging (ED) device with a Request to Exit (X) switch. Uses power supply 8Q00314 (on page D-5)	\$750.00

POWER SUPPLY OPTIONS (CONSULT FACTORY FOR LEAD TIMES)

Model #	Description	List Price Adder
8Q00312	Power supply for Electronic Latch Retraction Devices (LR/LRX)	\$725.00
8Q00313	Power supply with Day/Night mode for Electronic Latch Retraction Devices (LR/LRX)	\$825.00

Electrified Product Specifications

- Consult Factory for lead times
- Electrification prices should be added to price of device
- Continuous duty solenoids
- Tie into alarm systems and electromagnetic locks
- 24V AC/DC with .150 amp current
- Lifetime warranty on exit device; 1 year warranty on electronic components
- LR or LRX requires power supply 8Q00312 or 8Q00313
- Minimum door width 36"
- LR and ED requires the removal of mechanical dogging mechanism
- Options can be used in any Hex Dog or Fire Rated QED 100 Series Device (How to order example: QED111LR 36" 626)

Power Supply Specifications (10" x 10" x 4.25")

- 8Q00312**
- provides power for up to two LR or LRX devices
 - supplied with wiring diagram in detailed instructions
 - automatic door operator interface
 - Independent control of single exit devices (one or two single doors) or sequential operation of two devices (pair of doors)
 - field adjustable latch retraction time delay
 - 24VDC or 12VDC auxiliary power, unfiltered and unregulated
- 8Q00313**
- same as 8Q00312 with the addition of a day/night mode
 - provides separate input for retracting one exit device or two exit devices sequentially without activating the auto door operator. While the latches are held retracted auto operator can be activated independently from a different output.



QED100 series

Grade 1 Heavy Duty Exit Devices

LATCH & ROD PARTS (SPECIFY FINISH)

	Description	Service Part #	List Price
	Top Rod Latch for SVR & LBR - QED114 - QED119 (requires screw pack 8Q00268 - page J-10)	8Q00256	\$102.00
	Top Rod Latch for CVR - QED124 - QED129 (requires screw pack 8Q00278 - page J-10)	8Q00271	\$102.00
	Bottom Rod Latch for SVR - QED114, QED115 & QED116 (requires screw pack 8Q00268 - page J-10)	8Q00257	\$102.00
	Bottom Rod Latch for CVR - QED124 - QED129 (requires screw pack 8Q00278 - page J-10)	8Q00272	\$102.00
	Fire Latch for QED119 & QED129 LBR Fire Rated * Can only be used with fire rated LBR devices.	8Q00279	\$53.50
	Bottom Rod for SVR - QED114, QED115 & QED116 (requires screw pack 8Q00268 - page J-10)	8Q00258	\$21.50
	Bottom Rod for CVR - QED124 - QED129	8Q00280	\$21.50
	7' Top Rod for SVR & LBR - QED114 - QED119	8Q00259	\$23.50
	7' Top Rod for CVR - QED124 - QED129	8Q00281	\$23.50
	8' Top Rod for SVR & LBR - QED114 - QED119	8Q00260	\$25.50
	8' Top Rod for CVR - QED124 - QED129	8Q00282	\$25.50
	QED100 Series SVR & LBR, 7' Top Rod Cover Set (includes top rod and base plate) (requires screw pack 8Q00261 - page J-10)	8Q00249	\$48.00
	QED100 Series SVR & LBR, 8' Top Rod Cover Set (includes cover and base plate) (requires screw pack 8Q00261 - page J-10)	8Q00250	\$53.50
	QED100 Series SVR, Bottom Rod Cover Set (includes cover and base plate) (requires screw pack 8Q00261 - page J-10)	8Q00251	\$43.00



STRIKE PARTS

	Description	Service Part #	List Price
	Strike Kit for Rim Panic - QED111 & QED112 (includes mounting hardware)	8Q00254	\$21.50
	Strike Kit for Rim Fire Rated - QED113 (includes mounting hardware)	8Q00255	\$23.50
	Double Door Strike Kit for Rim Panic - QED111 & QED112 (includes mounting hardware)	8Q00269	\$43.00
	Strike Kit for Top Latch for SVR Panic - QED114, QED115, QED117 & QED118 (includes mounting hardware)	8Q00247	\$32.00
	Strike Kit for Top Latch for CVR Panic - QED124, QED125, QED127 & QED128	8Q00273	\$32.00
	Strike Kit for Top Latch for SVR Fire - QED116 & QED119 (includes mounting hardware)	8Q00248	\$34.00
	Strike Kit for Top Latch for CVR Fire - QED126 & QED129	8Q00274	\$34.00
	Strike Kit for Bottom Latch for SVR/CVR Panic - QED114, QED115, QED124 & QED125 (includes mounting hardware)	8Q00265	\$30.00
	Strike Kit for Bottom Latch for SVR/CVR Fire - QED116 & QED126 (includes mounting hardware)	8Q00266	\$32.00
	Strike Shim Kit for QED100 Series Rim Devices - 1 Piece (2 3/4" Backset for QED100 Series)	8Q00285	\$5.50



CYLINDER OPTIONS (SPECIFY FINISH)

Order # With Lock	Description	Service Part #	List Price	Quantity
6-PIN MORTISE CYLINDERS - 1-1/8" Housing, Standard Cam				
KW-M6	Kwikset KW 6-Pin Mortise Cylinder	9Q0009-010	\$43.00	1
	Kwikset KW 6-Pin Mortise Cylinder (Zero Bitted)	8Q00022	\$43.00	1
WE-M6	Weiser WE 6-Pin Mortise Cylinder	9Q0009-011	\$43.00	1
	Weiser WE 6-Pin Mortise Cylinder (Zero Bitted)	8Q00024	\$43.00	1
SC-M6	Schlage SC 6-Pin Mortise Cylinder	9Q0009-012	\$43.00	1
	Schlage SC 6-Pin Mortise Cylinder (Zero Bitted)	8Q00026	\$43.00	1
LA-M6	Sargent LA 6-Pin Mortise Cylinder	9Q0009-014	\$43.00	1
	Sargent LA 6-Pin Mortise Cylinder (Zero Bitted)	8Q00028	\$43.00	1
GA-M6	Yale GA 6-Pin Mortise Cylinder	9Q0009-013	\$43.00	1
	Yale GA 6-Pin Mortise Cylinder (Zero Bitted)	8Q00027	\$43.00	1
BF-M6	SFIC BF 6-Pin Mortise Cylinder - Small Format IC Core	8Q00238	\$66.00	1
5-PIN MORTISE CYLINDERS - 1-1/8" Housing, Standard Cam				
KW-M5	Kwikset KW 5-Pin Mortise Cylinder	9Q0009-022	\$43.00	1
	Kwikset KW 5-Pin Mortise Cylinder (Zero Bitted)	8Q00023	\$43.00	1
WE-M5	Weiser WE 5-Pin Mortise Cylinder	9Q0009-023	\$43.00	1
	Weiser WE 5-Pin Mortise Cylinder (Zero Bitted)	8Q00025	\$43.00	1
SC-M5	Schlage SC 5-Pin Mortise Cylinder	9Q0009-059	\$43.00	1
	Schlage SC 5-Pin Mortise Cylinder (Zero Bitted)	8Q00054	\$43.00	1

* Consult factory for other cylinder options.















* Refer to cylinder, keys & keying section for keying charges and cylinder finishes.



QED100 series

Grade 1 Heavy Duty Exit Devices

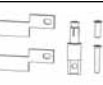
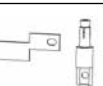
OTHER PARTS & SCREW PACKS

	Description	Service Part #	List Price	Qty
	QED100 Series End Cap (Specify finish)	8Q00264	\$21.50	1
	QED100 Series End Cap Bracket and Screw Pack	8Q00246	\$8.50	1
	QED100 Series SVR & LBR, Top & Bottom Latch Screw Pack (Specify finish)	8Q00268	\$13.50	1
	QED100 Series SVR & LBR, Rod Cover Screw Pack	8Q00261	\$11.00	1
	QED100 Series SVR & LBR, Latch Cover Screw Pack (Specify finish)	8Q00262	\$5.00	1
	QED100 Series SVR, Rod Connector Kit (connects top & bottom rod to exit device)	8Q00263	\$13.00	1
	QED100 Series Sex Bolts (Qty 4) (Specify finish)	8Q00267	\$15.00	1
	QED100 Series LBR, Head Cap Plug (black)	8Q00270	\$5.00	1
	QED100 Series Cylinder Mounting Kit for Cylinder Dog Devices - QED112, QED115 & QED118 (Specify finish)	8Q00252	\$21.50	1
	QED100 Series Hex Wrench for Hex Dog Devices (4mm) - QED111, QED114 & QED117	8Q00253	\$3.50	1
	Standard Cam for Mortise Cylinder	8Q00119	\$1.25	1
	Cam Mounting Screws for Mortise Cylinders (Qty 2)	8Q00118	\$0.75	1
	QED100 Series CVR rod connector	8Q00275	\$13.00	1
	QED100 Series CVR-LBR rod connector	8Q00276	\$13.00	1
	QED100 Series CVR installation jig	8Q00277	\$5.50	1
	QED100 Series CVR latch screw pack	8Q00278	\$13.00	1



QED100 series

Grade 1 Heavy Duty Exit Devices

THICK DOOR KITS (TDK's)

Thick door kits (TDK's) are used to extend the length of the exit trim spindle for non-standard (1 3/4") thick doors. These kits include appropriate length exit trim spindles and fasteners.



Trim	Door Thickness				List Price
	2"	2 1/4"	2 1/2"	2 3/4"	
QET130	8Q00427	8Q00428	8Q00429	8Q00430	\$16.00
QET160					
QET165	8Q00431	8Q00432	8Q00433	8Q00434	

* Consult factory for alternative door thicknesses.

GLASS BEAD KITS (GBK's) (SPECIFY FINISH)

- Glass bead kits (GBK's) are used to shim exit devices off the face of a door with raised glass beads. Each kit contains (2) 1/8" shims (total clearance of 1/4") and fasteners.
- Requires the use of a thick door kit (TDK) if using an exit device trim.
- Available finishes: 605, 313, 626

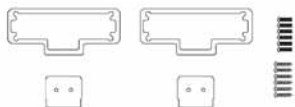

RIM

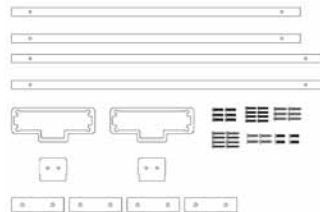

SVR

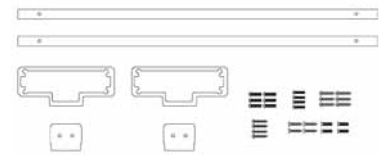

LBR

Part #	Device Type	Model	Finishes	List Price
8Q00414	RIM	QED111, QED112, QED113	605,313,626	\$53.50
8Q00415	SVR 7'	QED114, QED115, QED116		\$139.00
8Q00416	SVR 8'			\$144.50
8Q00417	LBR 7'	QED117, QED118, QED119		\$96.00
8Q00418	LBR 8'			\$96.00

* Consult factory for alternative door thicknesses.



QED100 series

Grade 1 Heavy Duty Exit Devices

Applications

Use with Rim Exit Devices on non-fire rated pairs of doors.

Product Specifications

- 11 Gage, 2" x 3" (51mm x 76mm) Steel mullion tube
- Utilizes standard rim cylinder (sold separately - see cylinders, keys & keying section)
- Latching top bracket allows mullion tube to be removed in seconds
- Standard shims included: 1/2" (13mm) and 5/8" (16mm)
- Non-Fire rated mullions utilize standard strikes
- Primer grey finish



KEYED REMOVEABLE MULLIONS (CONSULT FACTORY FOR MULLION LEAD TIMES)

Description	Service Part #	List Price
Non-Fire Rated Mullion Kits (Includes Mullion tube, top & bottom brackets, shims and fasteners)		
7' Non-Fire Rated Mullion Kit (2.13m)	8Q00408	\$1000.00
8' Non-Fire Rated Mullion Kit (2.44m)	8Q00409	\$1000.00
10' Non-Fire Rated Mullion Kit (3.05m)	8Q00410	\$1100.00

* Rim cylinders sold separately - refer to cylinders, keys & keying section for details.

* Consult factory for lead times.



K2 Products are simple to order. Our numbering system follows a logical progression that enables you to make sure you get exactly what you need, the first time. We don't over complicate things, we keep it simple ...just part of being the "Easiest to do Business with"

If you have a question, feel free to call one of our customer service representatives, they are ready to assist you...866-590-2094

DL - Dummy Trim Lever	20
DP - Dummy Trim Pull	25
PL - Passage Lever	30
KL - Keyed Lever	60
TP - Thumbpiece	65
DT - Dummy Thumbpiece	67
NL - Night Latch Lever	70
NL - Pull	75
Flat Plate	90

605	Bright Brass
613†	Oil Rubbed Bronze
626	Satin Chrome
690†	Painted Duranodic Bronze

QET1	60	SUM	626	KW	KD	XXXX
Series	Function	Design	Finish	Keyway	Keying	Notes

Grade 1 Architectural Exit Trim	QET1xx
---------------------------------	--------

Pull	PUL
Sierra	SIE
Summit	SUM

KD	Keyed Different
KA	Keyed Alike
CK	Construction Keyed
CMK	Construction Master Keyed
MAIS	Maison Keyed
MK	Master Keyed
GMK	Grand Master Keyed
GGMK	Great Grand Master Keyed
ZB	Zero Bitted

Kwikset "KW"*	KW
Weiser "E"*	WE
Schlage "C"*	SC
Yale "GA"	GA
Sargent "LA"	LA
SFIC "F"	BF
Less Cylinder	LC

* Available in 6-pin & 5-pin. 6-pin is standard.

† 613 Finish available for lever escutcheon trims; 690 finish available for escutcheon pull trims

Example

If you ordered: QET160 SUM 626 KW KD

You would get: Grade 1 Escutcheon Trim Lever, Summit design, Satin Chrome Finish Kwikset Keyway, Keyed Different. This Trim Matches to the QED100 Series Exit Devices



QET100 series

Grade 1 Heavy Duty Exit Trims



Model/Series	Functions	Style	Cylinder Type	Price	Quantity
				605, 613, 626	
QET120	Dummy Escutcheon Lever	SIE / SUM	-	\$ 321.00	6
QET130	Passage Escutcheon Lever	SIE / SUM	-	\$ 321.00	6
QET160	Keyed Escutcheon Lever (Classroom)	SIE / SUM	Mortise	\$ 321.00	6
QET170	Night Escutcheon Latch (Storeroom)	SIE / SUM	Rim	\$ 321.00	6

NOTES:
CYLINDERS ORDERED SEPARATELY. CYLINDER OPTIONS AND PRICING ON PAGE K12 & K13.
 *613 Finish trims match 313 finish exit devices.

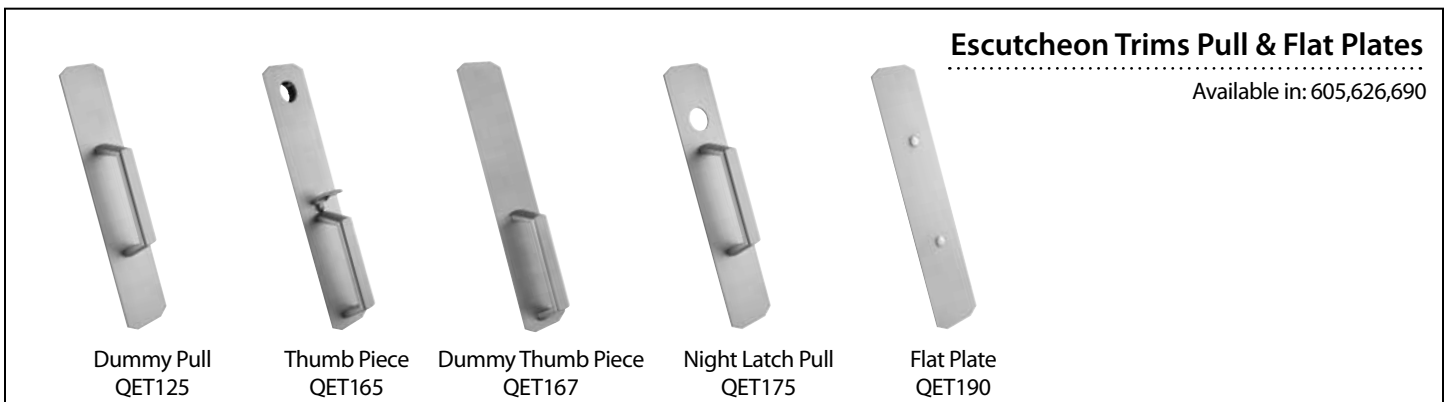

Model/Series	Functions	Style	Cylinder Type	Price	Quantity
				605, 626, 690	
QET125	Dummy Escutcheon Pull	PUL	-	\$ 102.00	6
QET165	Thumbpiece Escutcheon Pull	PUL	Mortise	\$ 198.00	6
QET167	Dummy Thumbpiece Escutcheon Pull	PUL	-	\$ 102.00	6
QET175	Night Latch Escutcheon Pull	PUL	Rim	\$ 102.00	6
QET190	Flat Escutcheon Plate	PUL	-	\$ 59.00	6

NOTES:
CYLINDERS ORDERED SEPARATELY. CYLINDER OPTIONS AND PRICING ON PAGE K12 & K13.



CYLINDER OPTIONS (SPECIFY FINISH)

Order # With Lock	Description	Service Part #	List Price	Quantity
6-PIN MORTISE CYLINDERS - 1-1/8" Housing, Standard Cam				
KW-M6	Kwikset KW 6-Pin Mortise Cylinder	9Q0009-010	\$43.00	1
	Kwikset KW 6-Pin Mortise Cylinder (Zero Bitted)	8Q00022	\$43.00	1
WE-M6	Weiser WE 6-Pin Mortise Cylinder	9Q0009-011	\$43.00	1
	Weiser WE 6-Pin Mortise Cylinder (Zero Bitted)	8Q00024	\$43.00	1
SC-M6	Schlage SC 6-Pin Mortise Cylinder	9Q0009-012	\$43.00	1
	Schlage SC 6-Pin Mortise Cylinder (Zero Bitted)	8Q00026	\$43.00	1
LA-M6	Sargent LA 6-Pin Mortise Cylinder	9Q0009-014	\$43.00	1
	Sargent LA 6-Pin Mortise Cylinder (Zero Bitted)	8Q00028	\$43.00	1
GA-M6	Yale GA 6-Pin Mortise Cylinder	9Q0009-013	\$43.00	1
	Yale GA 6-Pin Mortise Cylinder (Zero Bitted)	8Q00027	\$43.00	1
BF-M6	SFIC BF 6-Pin Mortise Cylinder - Small Format IC Core	8Q00238	\$66.00	1
5-PIN MORTISE CYLINDERS - 1-1/8" Housing, Standard Cam				
KW-M5	Kwikset KW 5-Pin Mortise Cylinder	9Q0009-022	\$43.00	1
	Kwikset KW 5-Pin Mortise Cylinder (Zero Bitted)	8Q00023	\$43.00	1
WE-M5	Weiser WE 5-Pin Mortise Cylinder	9Q0009-023	\$43.00	1
	Weiser WE 5-Pin Mortise Cylinder (Zero Bitted)	8Q00025	\$43.00	1
SC-M5	Schlage SC 5-Pin Mortise Cylinder	9Q0009-059	\$43.00	1
	Schlage SC 5-Pin Mortise Cylinder (Zero Bitted)	8Q00054	\$43.00	1

* Consult factory for other cylinder options.

* Refer to cylinder, keys & keying section for keying charges and cylinder finishes.



CYLINDER OPTIONS (SPECIFY FINISH)

Order # With Lock	Description	Service Part #	List Price	Quantity
6-PIN RIM CYLINDERS				
KW-M6	Kwikset KW 6-Pin Rim Cylinder	9Q0009-015	\$43.00	1
	Kwikset KW 6-Pin Rim Cylinder (Zero Bitted)	8Q00029	\$43.00	1
WE-M6	Weiser WE 6-Pin Rim Cylinder	9Q0009-016	\$43.00	1
	Weiser WE 6-Pin Rim Cylinder (Zero Bitted)	8Q00031	\$43.00	1
SC-M6	Schlage SC 6-Pin Rim Cylinder	9Q0009-017	\$43.00	1
	Schlage SC 6-Pin Rim Cylinder (Zero Bitted)	8Q00033	\$43.00	1
LA-M6	Sargent LA 6-Pin Rim Cylinder	9Q0009-019	\$43.00	1
	Sargent LA 6-Pin Rim Cylinder (Zero Bitted)	8Q0035	\$43.00	1
GA-M6	Yale GA 6-Pin Rim Cylinder	9Q0009-018	\$43.00	1
	Yale GA 6-Pin Rim Cylinder (Zero Bitted)	8Q00034	\$43.00	1
BF-M6	SFIC BF 6-Pin Rim Cylinder - Small Format IC Core	8Q00239	\$66.00	1
5-PIN RIM CYLINDERS				
KW-M5	Kwikset KW 5-Pin Rim Cylinder	9Q0009-020	\$43.00	1
	Kwikset KW 5-Pin Rim Cylinder (Zero Bitted)	8Q00030	\$43.00	1
WE-M5	Weiser WE 5-Pin Rim Cylinder	9Q0009-021	\$43.00	1
	Weiser WE 5-Pin Rim Cylinder (Zero Bitted)	8Q00032	\$43.00	1
SC-M5	Schlage SC 5-Pin Rim Cylinder	9Q0009-058	\$43.00	1
	Schlage SC 5-Pin Rim Cylinder (Zero Bitted)	8Q00055	\$43.00	1

* Consult factory for other cylinder options.

* Refer to cylinder, keys & keying section for keying charges and cylinder finishes.



QET100 series

Grade 1 Heavy Duty Exit Trims

OTHER PARTS & SCREW PACKS

	Description	Service Part #	List Price	Qty
	QET100 Series Screw Pack and Square Pin for Escutcheon Trims - QET120, QET130, QET160, QET170	8Q00132	\$3.75	1
	QET100/QET300 Series Screw Pack for Pull Plates - QET125, QET175, QET325 & QET375	8Q00134	\$0.75	1
	QET100 Series Cylinder Mounting Kit (Specify finish)	8Q00135	\$18.50	1
	QET100/QET300 Series Cylinder Lock and Screw Pack for Thumb Piece Pulls - QET165 & QET365 (Specify finish)	8Q00136	\$4.50	1
	QET100/QET300 Series Sex Nuts for Flat Plate - QET190 & QET390 (Qty 2) (Specify finish)	8Q00139	\$4.50	1
	Rim Cylinder Tailpiece	8Q00140	\$1.75	1
	Rim Cylinder Tailpiece – Thick Door (measures 2-3/8")	8Q00480	\$1.75	1
	Standard Cam for Mortise Cylinder	8Q00119	\$1.25	1
	Cam Mounting Screws for Mortise Cylinders (Qty 2)	8Q00118	\$0.75	1



K2 Products are simple to order. Our numbering system follows a logical progression that enables you to make sure you get exactly what you need, the first time. We don't over complicate things, we keep it simple ... just part of being the "Easiest to do Business with"

If you have a question, feel free to call one of our customer service representatives, they are ready to assist you...866-590-2094

Rim Hex Dog	11
Rim Cylinder Dog	12
Rim Fire Rated	13
SVR Hex Dog	14
SVR - Cylinder Dog	15
SVR - Fire Rated	16
SVR - LBR - Hex Dog	17
SVR - LBR - Cylinder Dog	18
SVR - LBR - Fire Rated	19

KW*	Kwikset "KW"
WE*	Weiser "E"
SC*	Schlage "C"
GA	Yale "GA"
LA	Sargent "LA"
BF	SFIC "F"
LC	Less Cylinder

QED3	15	36"	7FT	613	KW	KD	XXXX
Series	Function	Size	Trim*	Finish	Keyway**	Keying**	Notes

Grade 1 Standard Duty Exit Device	QED3xx
-----------------------------------	---------------

36" Device	36"
48" Device	48"

7 ft Rod	7FT
8 ft Rod	8FT

Painted Aluminum	689
Painted Duranodic Bronze	690

KD	Keyed Different
KA	Keyed Alike
CK	Construction Keyed
CMK	Construction Master Keyed
MAIS	Maison Keyed
MK	Master Keyed
GMK	Grand Master Keyed
GGMK	Great Grand Master Keyed
ZB	Zero Bitted

* Applies to Surface Vertical Rods only

** Applies to Cylinder Dogged only

* Available in 6-pin & 5-pin. 6-pin is standard.

Example

If you ordered: QED315 36" 7FT 689 KW KD

You would get: Grade 1 Standard Duty Surface Vertical Rod Exit Device 36", with Cylinder Dogging for a 7 Foot Door, in Painted Aluminum finish. Kwikset Keyway, Keyed Different.



Standard Duty Exit Device

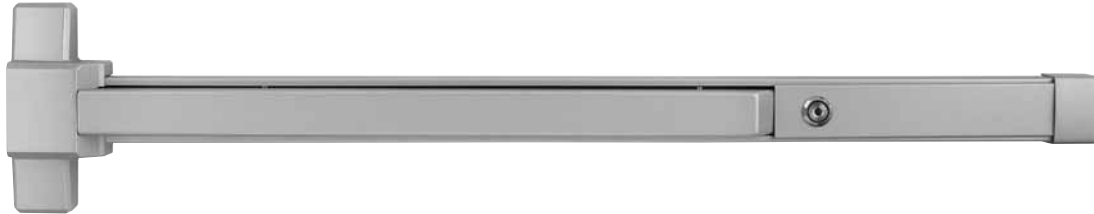

Available in: 689 & 690

Model/Series	Functions	Style	List Price	Case Quantity
			689, 690	
QED311	Rim - Hex Dog		\$205.00	4
QED312*	Rim - Cylinder Dog		\$205.00	4
QED313	Rim - Fire Rated		\$278.00	4
QED314	Surface Vertical Rod - Hex Dog	7FT	\$336.00	4
QED315*	Surface Vertical Rod - Cylinder Dog	7FT	\$336.00	4
QED316	Surface Vertical Rod - Fire Rated	7FT	\$430.00	4
QED317	Surface Vertical Rod Less Bottom Rod - Hex Dog	7FT	\$325.00	4
QED318*	Surface Vertical Rod Less Bottom Rod - Cylinder Dog	7FT	\$325.00	4
QED319	Surface Vertical Rod Less Bottom Rod - Fired Rated	7FT	\$430.00	4

NOTES:







* CYLINDERS ORDERED SEPARATELY. CYLINDER OPTIONS AND PRICING ON PAGE L-5
 QED319 INCLUDES BOTTOM FIRE LATCH

Trim Options

8FT	Vertical rod kit for 8FT door application	Add \$7.50
48"	48" Device	Add \$12.50







LATCH & ROD PARTS (SPECIFY FINISH)

	Description	Service Part #	List Price
	Top Rod Latch for SVR & LBR - QED314 - QED319 (requires screw pack 8Q00130 - page K-9)	8Q00111	\$73.50
	Bottom Rod Latch for SVR - QED314 & QED315 (requires screw pack 8Q00130 - page K-9)	8Q00112	\$73.50
	Bottom Rod Latch for SVR Fire Rated - QED316 (requires screw pack 8Q00130 - page K-9)	8Q00113	\$73.50
	Fire Latch for QED319 SVR-LBR-Fire Rated *Can only be used with Fire Rated LBR devices.	8Q00279	\$53.50
	7' Top Rod for SVR & LBR - QED314 - QED319	8Q00114	\$65.50
	8' Top Rod for SVR & LBR - QED314 - QED319	8Q00115	\$71.00
	Bottom Rod for SVR - QED314, QED315, QED316	8Q00116	\$71.00

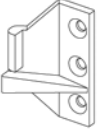
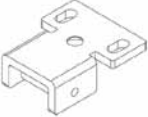
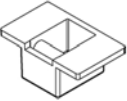

STRIKE PARTS

	Description	Service Part #	List Price
	Strike for Rim Panic - QED311 & QED312 (includes mounting hardware)	8Q00120	\$16.00
	Strike for Rim Fire Rated - QED313 (includes mounting hardware)	8Q00121	\$16.00
	Double Door Strike for Rim Panic - QED311 & QED312 (includes mounting hardware)	8Q00208	\$36.50
	Strike for Top Latch for SVR & LBR - QED314 - QED319 (includes mounting hardware)	8Q00128	\$16.00
	Strike for Bottom Latch for SVR - QED314, QED315 & QED316 (includes mounting hardware)	8Q00127	\$16.00
	Strike Shim Kit for Rim Devices - 1 piece (2 3/8" Backset for QED300 series)	8Q00285	\$5.50
	Strike Shim Kit for Rim Devices - 4 piece (2 3/4" Backset for QED300 series)	8Q00286	\$16.00



CYLINDER OPTIONS (SPECIFY FINISH)

Order # With Lock	Description	Service Part #	List Price	Quantity
6-PIN MORTISE CYLINDERS - 1-1/8" Housing, Standard Cam				
KW-M6	Kwikset KW 6-Pin Mortise Cylinder	9Q0009-010	\$43.00	1
	Kwikset KW 6-Pin Mortise Cylinder (Zero Bitted)	8Q00022	\$43.00	1
WE-M6	Weiser WE 6-Pin Mortise Cylinder	9Q0009-011	\$43.00	1
	Weiser WE 6-Pin Mortise Cylinder (Zero Bitted)	8Q00024	\$43.00	1
SC-M6	Schlage SC 6-Pin Mortise Cylinder	9Q0009-012	\$43.00	1
	Schlage SC 6-Pin Mortise Cylinder (Zero Bitted)	8Q00026	\$43.00	1
LA-M6	Sargent LA 6-Pin Mortise Cylinder	9Q0009-014	\$43.00	1
	Sargent LA 6-Pin Mortise Cylinder (Zero Bitted)	8Q00028	\$43.00	1
GA-M6	Yale GA 6-Pin Mortise Cylinder	9Q0009-013	\$43.00	1
	Yale GA 6-Pin Mortise Cylinder (Zero Bitted)	8Q00027	\$43.00	1
BF-M6	SFIC BF 6-Pin Mortise Cylinder - Small Format IC Core	8Q00238	\$66.00	1
5-PIN MORTISE CYLINDERS - 1-1/8" Housing, Standard Cam				
KW-M5	Kwikset KW 5-Pin Mortise Cylinder	9Q0009-022	\$43.00	1
	Kwikset KW 5-Pin Mortise Cylinder (Zero Bitted)	8Q00023	\$43.00	1
WE-M5	Weiser WE 5-Pin Mortise Cylinder	9Q0009-023	\$43.00	1
	Weiser WE 5-Pin Mortise Cylinder (Zero Bitted)	8Q00025	\$43.00	1
SC-M5	Schlage SC 5-Pin Mortise Cylinder	9Q0009-059	\$43.00	1
	Schlage SC 5-Pin Mortise Cylinder (Zero Bitted)	8Q00054	\$43.00	1

* Consult factory for other cylinder options.

* Refer to cylinder, keys & keying section for keying charges and cylinder finishes.



OTHER PARTS & SCREW PACKS

	Description	Service Part #	List Price	Qty
	QED300 Series Rim, Head Cap (Specify finish)	8Q00109	\$33.50	1
	QED300 Series SVR, Head Cap (Specify finish)	8Q00110	\$33.50	1
	Standard Cam for Mortise Cylinder	8Q00119	\$1.25	1
	Cam Mounting Screws for Mortise Cylinders (Qty 2)	8Q00118	\$0.75	1
	QED300 Series Cylinder Mounting Kit for Cylinder Dog Devices - QED312, QED315 & QED318 (Specify finish)	8Q00122	\$16.00	1
	QED300 Series LBR, Head Cap Plug (black)	8Q00117	\$1.25	1
	QED300 Series Hex Wrench for Hex Dog Devices (4.75mm) - QED311, QED314 & QED317	8Q00124	\$1.25	1
	QED300 Series Device Mounting Screw Pack	8Q00125	\$3.50	1
	QED300 Series SVR & LBR, Rod Holder Brackets and Screw Pack - QED314 - QED319 (Specify finish)	8Q00126	\$3.50	1
	QED300 Series SVR & LBR, Top & Bottom Latch Screw Pack (Specify finish)	8Q00130	\$3.50	1
	QED300 Series Sex Bolts (Qty 4) (Specify finish)	8Q00131	\$4.50	1
	QED300 Series End Cap (Specify finish)	8Q00123	\$16.00	1



THICK DOOR KITS (TDK's)

Thick door kits (TDK's) are used to extend the length of the exit trim spindle for non-standard (1 3/4") thick doors. These kits include appropriate length exit trim spindles and fasteners.



Trim	Door Thickness				List Price
	2"	2 1/4"	2 1/2"	2 3/4"	
QET330	8Q00419	8Q00420	8Q00421	8Q00422	\$13.00
QET360					
QET370					
QET365	8Q00423	8Q00424	8Q00425	8Q00426	

* Consult factory for alternative door thicknesses.

GLASS BEAD KITS (GBK's) (SPECIFY FINISH)

- Glass bead kits (GBK's) are used to shim exit devices off the face of a door with raised glass beads. Each kit contains (2) 1/8" shims (total clearance of 1/4") and fasteners.
- Requires the use of a thick door kit (TDK) if using an exit device trim.
- Available finishes: 689, 690

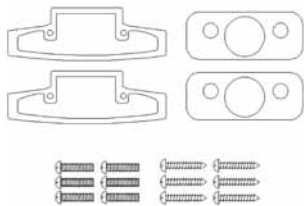

RIM

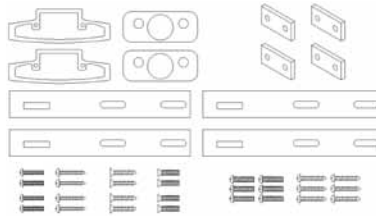

SVR

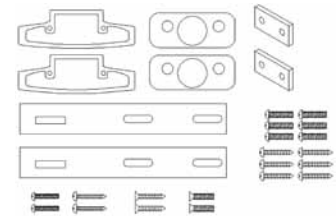

LBR

Part #	Device Type	Model	Finishes	List Price
8Q00411	RIM	QED311, QED312, QED313	689 & 690	\$31.50
8Q00412	SVR	QED314, QED315, QED316		\$42.00
8Q00413	LBR	QED317, QED318, QED319		\$36.50

* Consult factory for alternative door thicknesses.



QED300 series

Grade 1 Standard Duty Exit Devices

Applications

Use with Rim Exit Devices on non-fire rated pairs of doors.

Product Specifications

- 11 Gage, 2"x 3"(51mm x 76mm) Steel mullion tube
- Utilizes standard rim cylinder (sold separately - see cylinders, keys & keying section)
- Latching top bracket allows mullion tube to be removed in seconds
- Standard shims included: 1/2" (13mm) and 5/8" (16mm)
- Non-Fire rated mullions utilize standard strikes
- Primer grey finish



KEYED REMOVEABLE MULLIONS (CONSULT FACTORY FOR MULLION LEAD TIMES)

Description	Service Part #	List Price
Non-Fire Rated Mullion Kits (Includes Mullion tube, top & bottom brackets, shims and fasteners)		
7' Non-Fire Rated Mullion Kit (2.13m)	8Q00408	\$1000.00
8' Non-Fire Rated Mullion Kit (2.44m)	8Q00409	\$1000.00
10' Non-Fire Rated Mullion Kit (3.05m)	8Q00410	\$1100.00

* Rim cylinders sold separately - refer to cylinders, keys & keying section for details.

* Consult factory for lead times.



K2 Products are simple to order. Our numbering system follows a logical progression that enables you to make sure you get exactly what you need, the first time. We don't over complicate things, we keep it simple ...just part of being the "Easiest to do Business with"

If you have a question, feel free to call one of our customer service representatives, they are ready to assist you...866-590-2094

DL - Dummy Trim Lever	20
DP - Dummy Trim Pull	25
PL - Passage Lever	30
KL - Keyed Lever	60
TP - Thumbpiece	65
DT - Dummy Thumbpiece	67
NL - Night Latch Lever	70
NL - Pull	75
GW - Gull Wing	77
Flat Plate	90

689	Painted Aluminum
690	Painted Duranodic Bronze

QET3	60	PNN	689	KW	KD	XXXX
Series	Function	Design	Finish	Keyway	Keying	Notes

Grade 1 Standard Duty Exit Trim

QET3xx	Pull	PUL
	Pinnacle	PNN
	Pearce	PEA

Kwikset "KW"	KW
Weiser "E"	WE
Schlage "C"	SC
Yale "GA"	GA
Sargent "LA"	LA
SFIC "F"	BF
Less Cylinder	LC

KD	Keyed Different
KA	Keyed Alike
CK	Construction Keyed
CMK	Construction Master Keyed
MAIS	Maison Keyed
MK	Master Keyed
GMK	Grand Master Keyed
GGMK	Great Grand Master Keyed
ZB	Zero Bitted

* Available in 6-pin & 5-pin. 6-pin is standard.

Example

If you ordered: QET360 PNN 689 KW KD

You would get: Grade 1 Escutcheon Trim Lever, Pinnacle design, Aluminum Finish Kwikset Keyway, Keyed Different. This Trim Matches to the QED300 Series Exit Devices

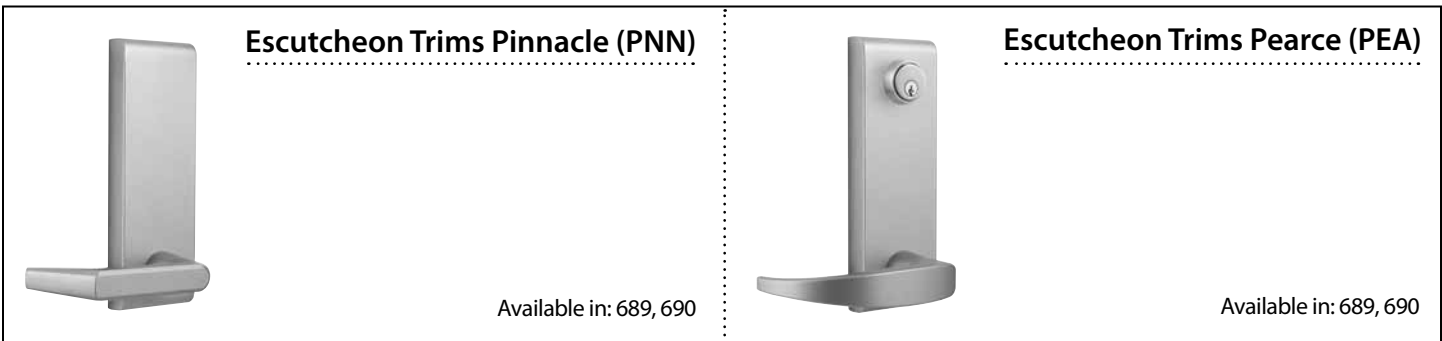

Model/Series	Functions	Style	Cylinder Type	Price	Quantity
				689,690	
QET320	Dummy Escutcheon Lever	PNN / PEA	-	\$ 147.00	12
QET330	Passage Escutcheon Lever	PNN / PEA	-	\$ 147.00	12
QET360	Keyed Escutcheon Lever (Classroom)	PNN / PEA	Mortise	\$ 147.00	12
QET370	Night Latch Escutcheon (Storeroom)	PNN / PEA	Mortise	\$ 147.00	12

NOTES:

CYLINDERS ORDERED SEPARATELY. CYLINDER OPTIONS AND PRICING ON PAGE L11 & L12.

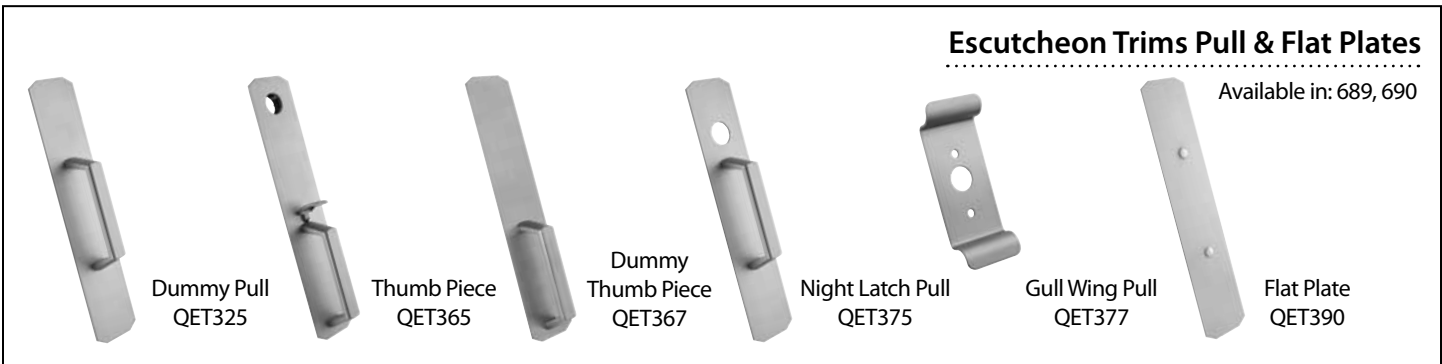

Model/Series	Functions	Style	Cylinder Type	Price	Quantity
				689,690	
QET325	Dummy Escutcheon Pull	PUL	-	\$ 68.00	12
QET365	Thumb Piece Escutcheon Pull	PUL	Mortise	\$ 163.00	12
QET367	Dummy Thumb Piece Escutcheon Pull	PUL	-	\$ 68.00	12
QET375	Night Latch Escutcheon Pull	PUL	Rim	\$ 68.00	12
QET377	Gull Wing Escutcheon Pull	PUL	Rim	\$ 26.50	12
QET390	Flat Escutcheon Plate	PUL	-	\$ 37.00	12

NOTES:

CYLINDERS ORDERED SEPARATELY. CYLINDER OPTIONS AND PRICING ON PAGE L11 & L12.



CYLINDER OPTIONS (SPECIFY FINISH)

Order # With Lock	Description	Service Part #	List Price	Quantity
6-PIN MORTISE CYLINDERS - 1-1/8" Housing, Standard Cam				
KW-M6	Kwikset KW 6-Pin Mortise Cylinder	9Q0009-010	\$43.00	1
	Kwikset KW 6-Pin Mortise Cylinder (Zero Bitted)	8Q00022	\$43.00	1
WE-M6	Weiser WE 6-Pin Mortise Cylinder	9Q0009-011	\$43.00	1
	Weiser WE 6-Pin Mortise Cylinder (Zero Bitted)	8Q00024	\$43.00	1
SC-M6	Schlage SC 6-Pin Mortise Cylinder	9Q0009-012	\$43.00	1
	Schlage SC 6-Pin Mortise Cylinder (Zero Bitted)	8Q00026	\$43.00	1
LA-M6	Sargent LA 6-Pin Mortise Cylinder	9Q0009-014	\$43.00	1
	Sargent LA 6-Pin Mortise Cylinder (Zero Bitted)	8Q00028	\$43.00	1
GA-M6	Yale GA 6-Pin Mortise Cylinder	9Q0009-013	\$43.00	1
	Yale GA 6-Pin Mortise Cylinder (Zero Bitted)	8Q00027	\$43.00	1
BF-M6	SFIC BF 6-Pin Mortise Cylinder - Small Format IC Core	8Q00238	\$66.00	1
5-PIN MORTISE CYLINDERS - 1-1/8" Housing, Standard Cam				
KW-M5	Kwikset KW 5-Pin Mortise Cylinder	9Q0009-022	\$43.00	1
	Kwikset KW 5-Pin Mortise Cylinder (Zero Bitted)	8Q00023	\$43.00	1
WE-M5	Weiser WE 5-Pin Mortise Cylinder	9Q0009-023	\$43.00	1
	Weiser WE 5-Pin Mortise Cylinder (Zero Bitted)	8Q00025	\$43.00	1
SC-M5	Schlage SC 5-Pin Mortise Cylinder	9Q0009-059	\$43.00	1
	Schlage SC 5-Pin Mortise Cylinder (Zero Bitted)	8Q00054	\$43.00	1

* Consult factory for other cylinder options.

* Refer to cylinder, keys & keying section for keying charges and cylinder finishes.



CYLINDER OPTIONS (SPECIFY FINISH)











Order # With Lock	Description	Service Part #	List Price	Quantity
6-PIN RIM CYLINDERS				
KW-M6	Kwikset KW 6-Pin Rim Cylinder	9Q0009-015	\$43.00	1
	Kwikset KW 6-Pin Rim Cylinder (Zero Bitted)	8Q00029	\$43.00	1
WE-M6	Weiser WE 6-Pin Rim Cylinder	9Q0009-016	\$43.00	1
	Weiser WE 6-Pin Rim Cylinder (Zero Bitted)	8Q00031	\$43.00	1
SC-M6	Schlage SC 6-Pin Rim Cylinder	9Q0009-017	\$43.00	1
	Schlage SC 6-Pin Rim Cylinder (Zero Bitted)	8Q00033	\$43.00	1
LA-M6	Sargent LA 6-Pin Rim Cylinder	9Q0009-019	\$43.00	1
	Sargent LA 6-Pin Rim Cylinder (Zero Bitted)	8Q00035	\$43.00	1
GA-M6	Yale GA 6-Pin Rim Cylinder	9Q0009-018	\$43.00	1
	Yale GA 6-Pin Rim Cylinder (Zero Bitted)	8Q00034	\$43.00	1
BF-M6	SFIC BF 6-Pin Rim Cylinder - Small Format IC Core	8Q00239	\$66.00	1
5-PIN RIM CYLINDERS				
KW-M5	Kwikset KW 5-Pin Rim Cylinder	9Q0009-020	\$43.00	1
	Kwikset KW 5-Pin Rim Cylinder (Zero Bitted)	8Q00030	\$43.00	1
WE-M5	Weiser WE 5-Pin Rim Cylinder	9Q0009-021	\$43.00	1
	Weiser WE 5-Pin Rim Cylinder (Zero Bitted)	8Q00032	\$43.00	1
SC-M5	Schlage SC 5-Pin Rim Cylinder	9Q0009-058	\$43.00	1
	Schlage SC 5-Pin Rim Cylinder (Zero Bitted)	8Q00055	\$43.00	1

* Consult factory for other cylinder options.

* Refer to cylinder, keys & keying section for keying charges and cylinder finishes.

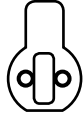

OTHER PARTS & SCREW PACKS

	Description	Service Part #	List Price	Qty
	QET100/QET300 Series Screw Pack for Pull Plates - QET125, QET175, QET325 & QET375	8Q00134	\$0.75	1
	QET100/QET300 Series Cylinder Lock and Screw Pack for Thumb Piece Pulls - QET165 & QET365	8Q00136	\$4.50	1
	QET300 Series Screw Pack, Cylinder Mounting Hardware & Square Pin for Escutcheon Trims - QET360 & QET370	8Q00137	\$7.00	1
	QET300 Series Screw Pack & Square Pin for Escutcheon Trims - QET320 & QET330	8Q00206	\$3.50	1
	QET300 Series Cylinder Collar (Specify finish)	8Q00138	\$18.50	1
	QET100/QET300 Series Sex Nuts for Flat Plate - QET190 & QET390 (Qty 2) (Specify finish)	8Q00139	\$4.50	1
	Rim Cylinder Tailpiece	8Q00140	\$1.75	1
	Rim Cylinder Tailpiece – Thick Door (measures 2-3/8")	8Q00480	\$1.75	1
	Standard Cam for Mortise Cylinder	8Q00119	\$1.25	1
	Cam Mounting Screws for Mortise Cylinders (Qty 2)	8Q00118	\$0.75	1



how to order:
**Grade 1 Standard Duty
 Round Rose Exit Trims**

K2 Products are simple to order. Our numbering system follows a logical progression that enables you to make sure you get exactly what you need, the first time. We don't over complicate things, we keep it simple ... just part of being the "Easiest to do Business with"

If you have a question, feel free to call one of our customer service representatives, they are ready to assist you...866-590-2094

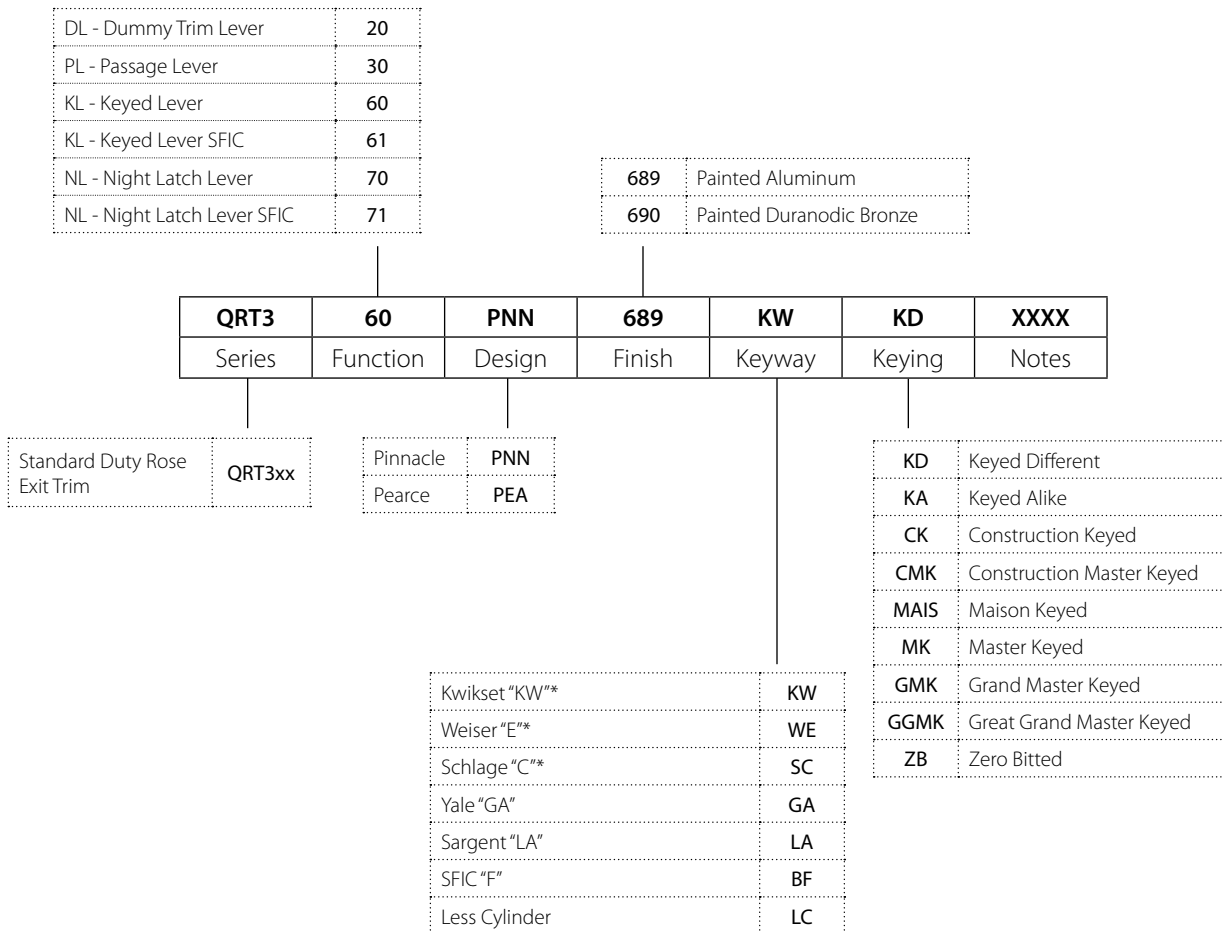

* Available in 6-pin & 5-pin. 6-pin is standard.

Example

If you ordered: QRT360 PNN 689 KW KD

You would get: Standard Duty Keyed Lever Round Rose Trim, Pinnacle Lever, Painted Aluminum Finish, Kwikset Keyway, Keyed Different. This Trim Matches to the QED300 Series Exit Devices



Round Rose Trims Pinnacle (PNN)

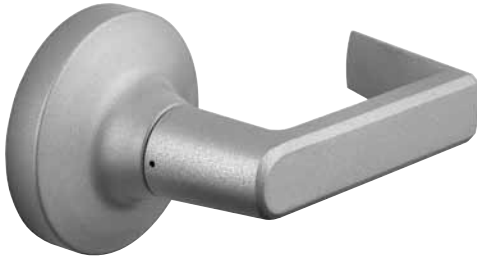

Available in: 689, 690

Round Rose Trims Pearce (PEA)



Available in: 689, 690

Model/Series	Functions	Style	Price	Case Quantity
			689, 690	
QRT320	Dummy Lever	PNN / PEA	\$95.00	12
QRT330	Passage Lever	PNN / PEA	\$95.00	12
QRT360	Keyed Lever (Classroom)	PNN / PEA	\$126.00	12
QRT361	Keyed Lever SFIC (Classroom)	PNN / PEA	\$149.00	12
QRT370	Keyed Lever (Storeroom)	PNN / PEA	\$126.00	12
QRT371	Night Latch SFIC (Storeroom)	PNN / PEA	\$149.00	12



QRT300 series

Grade 1 Standard Duty Round Rose Exit Trims

CYLINDER OPTIONS (SPECIFY FINISH)





Order # With Lock	Description	Price With Lock	Service Part #	Service Part List Price
6-PIN BRASS CYLINDERS				
KW6	Kwikset KW - 6-Pin Entry/Storeroom Cylinder (KD)	No Charge	8Q00001	\$11.00
	Kwikset KW - 6-Pin Classroom Cylinder (KD)	No Charge	8Q00004	\$11.00
	Kwikset KW - 6-Pin Entry/Storeroom/Classroom Cylinder (ZB or Pinned)	No Charge	9Q0009-001	\$11.00
WE6	Weiser WE - 6-Pin Entry/Storeroom Cylinder (KD)	No Charge	8Q00002	\$11.00
	Weiser WE - 6-Pin Classroom Cylinder (KD)	No Charge	8Q00005	\$11.00
	Weiser WE - 6-Pin Entry/Storeroom/Storeroom Cylinder (ZB or Pinned)	No Charge	9Q0009-002	\$11.00
SC6	Schlage SC - 6-Pin Entry/Storeroom Cylinder (KD)	No Charge	8Q00003	\$11.00
	Schlage SC - 6-Pin Classroom Cylinder (KD)	No Charge	8Q00006	\$11.00
	Schlage SC - 6-Pin Entry/Storeroom/Classroom Cylinder (ZB or Pinned)	No Charge	9Q0009-003	\$11.00
GA6	Yale GA - 6-Pin Lever/Deadbolt Cylinder	No Charge	9Q0009-004	\$43.00
LA6	Sargent LA - 6-Pin Lever/Deadbolt Cylinder	No Charge	9Q0009-005	\$43.00
BF6	SFIC BF- 6-Pin SFIC Cylinder	No Charge	8Q00036	\$34.00
5-PIN BRASS CYLINDERS				
KW5	Kwikset KW - 5-Pin Entry/Storeroom/Classroom Cylinder (ZB or Pinned)	No Charge	9Q0009-006	\$11.00
WE5	Weiser WE - 5-Pin Entry/Storeroom/Storeroom Cylinder (ZB or Pinned)	No Charge	9Q0009-007	\$11.00
SC5	Schlage SC - 5-Pin Entry/Storeroom/Classroom Cylinder (ZB or Pinned)	No Charge	9Q0009-057	\$11.00
LESS CYLINDER				
LC	Less Cylinder	Deduct \$11		
	Less SFIC Cylinder	Deduct \$34		

* Consult factory for other cylinder options.

* Refer to cylinder, keys & keying section for keying charges and cylinder finishes.



OTHER PARTS & SCREW PACKS

Description	Service Part #	List Price	Quantity
 Tailpiece QTL200 & QRT300 Series	8Q00073	\$1.75	1
 Screw pack for QRT300 series trims (Specify finish)	8Q00219	\$1.75	1
 Strike shim kit for rim devices - 1 piece (2 3/8" Backset for QED300 series)	8Q00285	\$5.50	1
 Strike shim kit for rim devices - 4 piece (2 3/4" Backset for QED300 series)	8Q00286	\$16.00	1



K2 Products are simple to order. Our numbering system follows a logical progression that enables you to make sure you get exactly what you need, the first time. We don't over complicate things, we keep it simple ... just part of being the "Easiest to do Business with"

If you have a question, feel free to call one of our customer service representatives, they are ready to assist you...866-590-2094

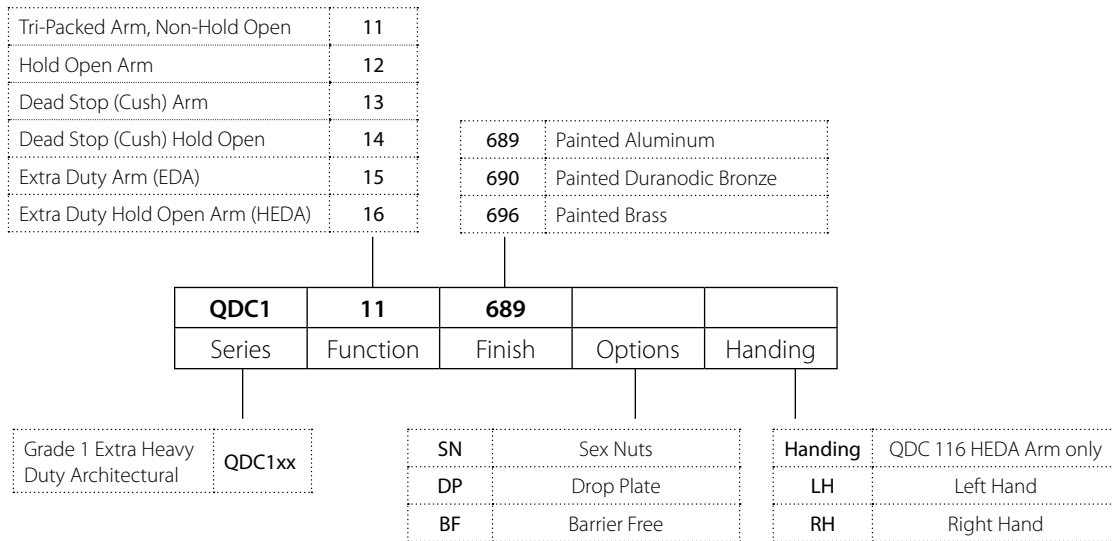

Example

If you ordered: QDC111 SN 689

You would get: Grade 1 Extra Heavy Duty Non-Hold Open Door Closer - Full Adjustable (Sized 1-6), Tri-packed Arms with Both Delayed Action & Back Check Standard, Painted Aluminum finish, and Sex Nuts



QDC100 series

Grade 1 Extra Heavy Duty Door Closers

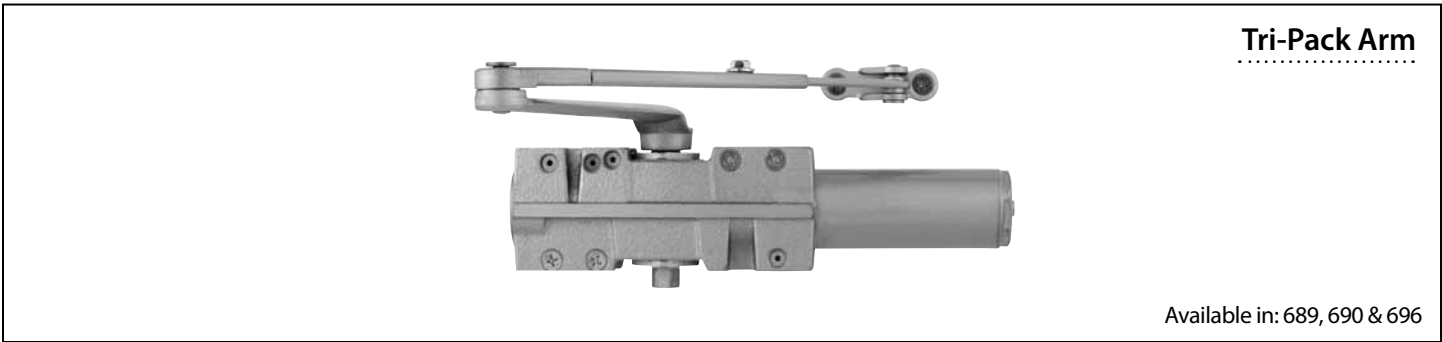

Model/Series	Functions	List Price	Quantity
		689, 690 & 696	
QDC111	Tri-Packed Arm, Non-Hold Open	\$241.00	3
QDC112	Hold-Open Arm	\$273.00	1
QDC113	Dead Stop (Cush) Arm	\$283.00	1
QDC114	Dead Stop (Cush) Hold-Open Arm	\$300.00	1
QDC115	Extra Duty Arm (EDA)	\$283.00	1
QDC116	Extra Duty Hold Open Arm (HEDA) - Handed	\$300.00	1

















Order with Closer	Description	With Closer	Service Part #	List Price
	SN Sex Nuts (Qty 4) (Specify finish)	Add \$4.50	8Q00097	\$4.50

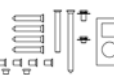

QDC100 series

Grade 1 Extra Heavy Duty Door Closers

OTHER PARTS & SCREW PACKS (SPECIFY FINISH)

	Description	Service Part #	List Price	Qty
	Tri-Pack Arm (requires screw pack 8Q00457)	8Q00462	\$44.00	1
	Hold-Open Arm (requires screw pack 8Q00458)	8Q00463	\$86.00	1
	Dead Stop (Cush) Arm (requires screw pack 8Q00459)	8Q00464	\$96.00	1
	Dead Stop (Cush) Hold-Open Arm (requires screw pack 8Q00459)	8Q00465	\$107.00	1
	Extra Duty Arm (EDA) (requires screw pack 8Q00460)	8Q00466	\$96.00	1
	Extra Duty Hold-Open Arm (HEDA) - Right Hand (requires screw pack 8Q00460)	8Q00467	\$107.00	1
	Extra Duty Hold-Open Arm (HEDA) - Left Hand (requires screw pack 8Q00460)	8Q00468	\$107.00	1
	QDC100 Series Plastic Cover	8Q00461	\$21.00	1
	Mounting Screw Pack for QDC100 Series	8Q00456	\$16.00	1
	Screw Pack for QDC111 Tri-Pack Arm	8Q00457	\$8.50	1
	Screw Pack for QDC112 Hold-Open Arm	8Q00458	\$8.50	1
	Screw Pack for QDC113 Dead Stop (cush) Arm & QDC114 Dead Stop (cush) Hold-Open Arm	8Q00459	\$8.50	1
	Screw Pack for QDC115 Extra Duty Arm (EDA) & QDC116 Extra Duty Hold-Open Arm (HEDA)	8Q00460	\$8.50	1
	QDC100 Drop Plate Kit - Pull Side (requires screw pack 8Q)	8Q00469	\$31.50	1
	QDC100 Drop Plate Kit - Push Side (requires screw pack 8Q)	8Q00470	\$31.50	1
	QDC100 Drop Plate Kit - Push Side, Parallel Arm (requires screw pack 8Q)	8Q00471	\$31.50	1
	QDC100 Drop Plate Kit - Push Side, Top Jamb (requires screw pack 8Q)	8Q00472	\$31.50	1
	Screw Pack for QDC100 Drop Plates	8Q00473	\$1.75	1



K2 Products are simple to order. Our numbering system follows a logical progression that enables you to make sure you get exactly what you need, the first time. We don't over complicate things, we keep it simple ... just part of being the "Easiest to do Business with"

If you have a question, feel free to call one of our customer service representatives, they are ready to assist you...866-590-2094

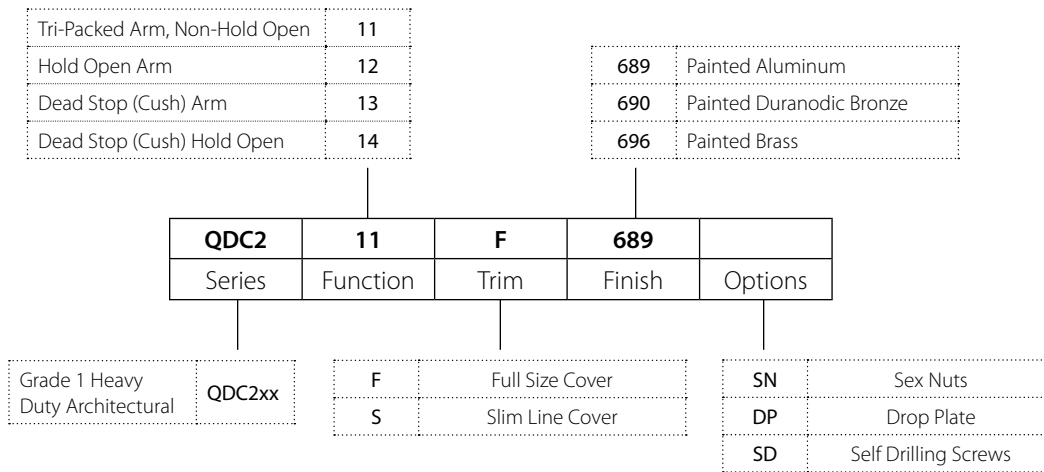

Example

If you ordered: QDC211 F SN 689

You would get: Grade 1 Heavy Duty Slim line Non -Hold Open Door Closer - Full Adjustable (Sized 1-6), Tri-packed Arms with Both Delayed Action & Back Check Standard, Full Sized cover, Painted Aluminum finish, and Sex Nuts



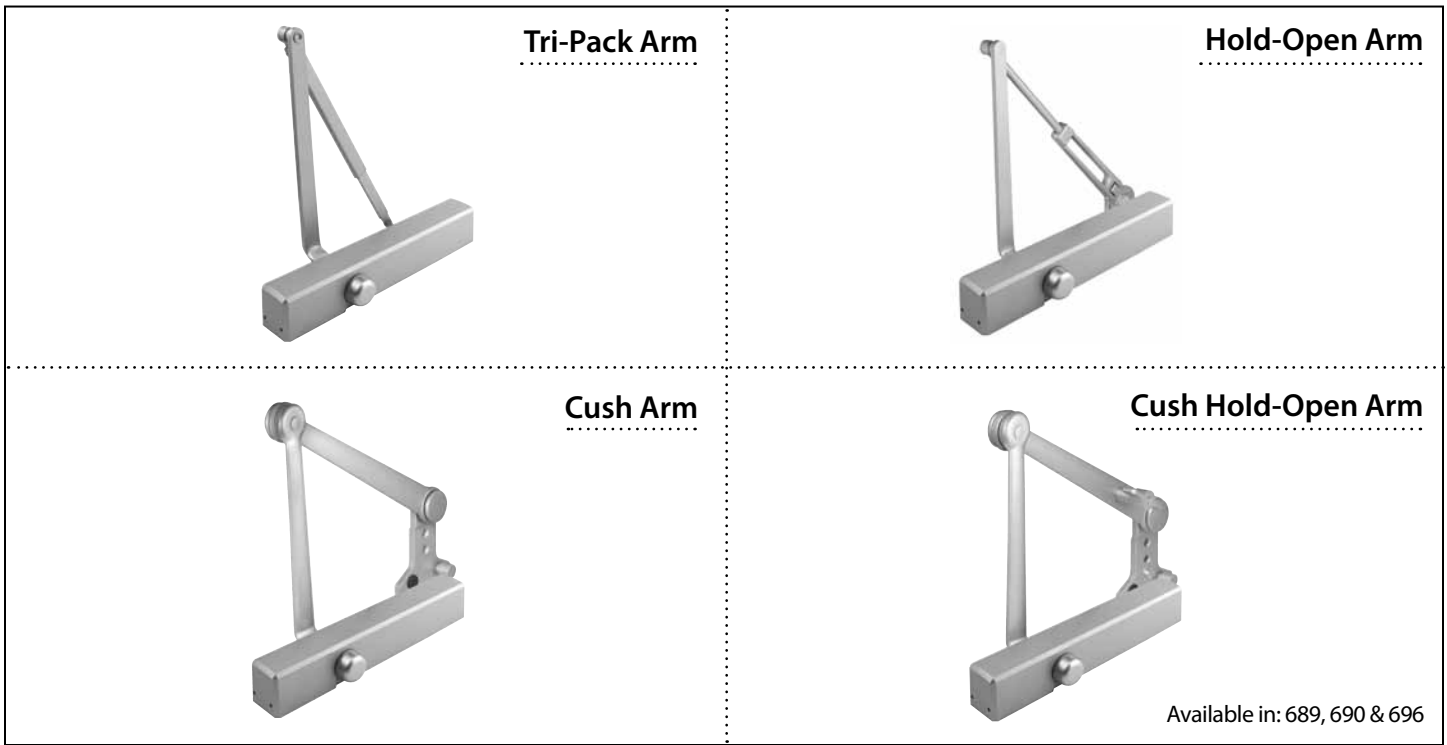

QDC200 series

Grade 1 Heavy Duty Door Closers



Model/Series	Functions	List Price	Quantity
		689, 690 & 696	
QDC211	Tri-Packed Arm, Non-Hold Open	\$ 180.00	6
QDC212	Hold-Open Arm	\$ 210.00	6
QDC213	Dead Stop (Cush) Arm	\$ 265.00	3
QDC214	Dead Stop (Cush) Hold-Open Arm	\$ 281.00	3













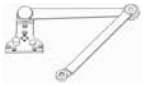

Order with Closer	Description	With Closer	Service Part #	List Price
 F	Full Size Cover (Specify finish)	No Charge	8Q00094	\$15.00
 S	Slim Cover (Specify finish)	No Charge	8Q00096	\$15.00
 SN	Sex Nuts (Qty 4) (Specify finish)	Add \$4.50	8Q00097	\$4.50
 SD	Self Drilling Screws (Qty 8) (Specify finish)	Add \$10.00	8Q00436	\$10.00



QDC200 series

Grade 1 Heavy Duty Door Closers

OTHER PARTS & SCREW PACKS (SPECIFY FINISH)

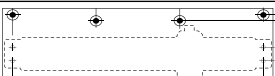
	Description	Service Part #	List Price	Qty
	QDC200 Series Plastic Installation Template	8Q00454	\$26.50	1
	Tri-Pack Arm (requires screw pack 8Q00100)	8Q00087	\$34.00	1
	Hold-Open Arm (requires screw pack 8Q00099)	8Q00088	\$66.50	1
	Dead Stop (Cush) Arm (requires screw pack 8Q00098)	8Q00089	\$77.00	1
	Dead Stop (Cush) Hold-Open Arm (requires screw pack 8Q00098)	8Q00090	\$87.50	1
	Pinion Cap - QDC200 Series	8Q00092	\$4.00	1
	Parallel Arm Bracket (requires screw pack 8Q00102)	8Q00093	\$6.50	1
	Screw Pack for QDC213 Dead Stop (Cush) Arm & QDC214 Dead Stop (Cush) Arm Hold-Open	8Q00098	\$1.75	1
	Screw Pack for QDC212 Hold-Open Arm	8Q00099	\$1.75	1
	Mounting Screw Pack for QDC200 Series	8Q00100	\$1.75	1
	Screw Pack for Parallel Arm Bracket	8Q00102	\$1.75	1
	Self Drilling Screw Pack (Qty 8)	8Q00436	\$10.00	1
	Small Drop Plate Kit for QDC200 Series, Pull & Push (2.44" x 12.97")	8Q00105	\$29.00	1
	Large Drop Plate Kit for QDC200 Series, Pull & Push (3.47" x 12.97")	8Q00106	\$29.00	1
	Small Drop Plate Kit for QDC200 Series, Pull (2.94" x 12.97")	8Q00107	\$29.00	1
	Large Drop Plate Kit for QDC200 Series, Pull	8Q00108	\$29.00	1



how to order: Door Closers

K2 Products are simple to order. Our numbering system follows a logical progression that enables you to make sure you get exactly what you need, the first time. We don't over complicate things, we keep it simple ... just part of being the "Easiest to do Business with"

If you have a question, feel free to call one of our customer service representatives, they are ready to assist you...866-590-2094

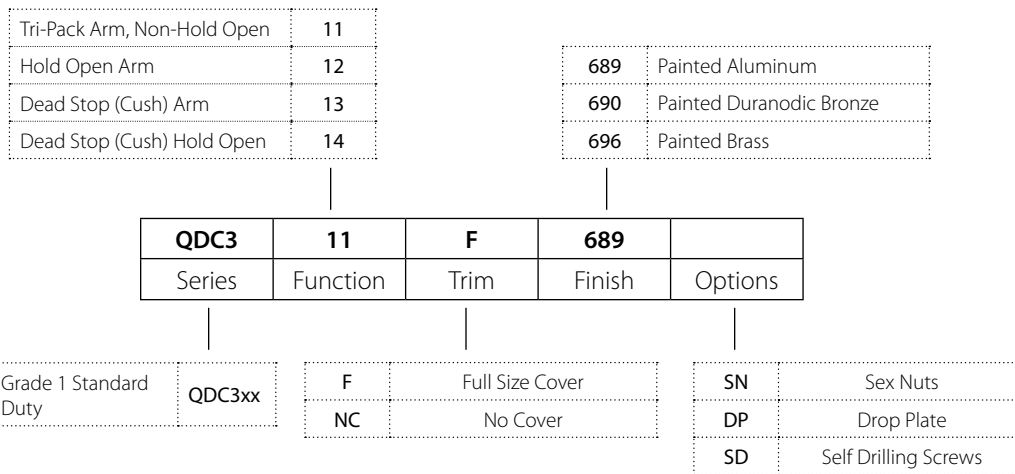

Example

If you ordered: QDC311 F SN 689

You would get: Grade 1 Standard Duty Non-Hold Open Door Closer - Full Adjustable (Sized 1-6), Tri-packed Arms with Both Delayed Action & Back Check Standard, Full Sized cover, Painted Aluminum finish, and Sex Nuts



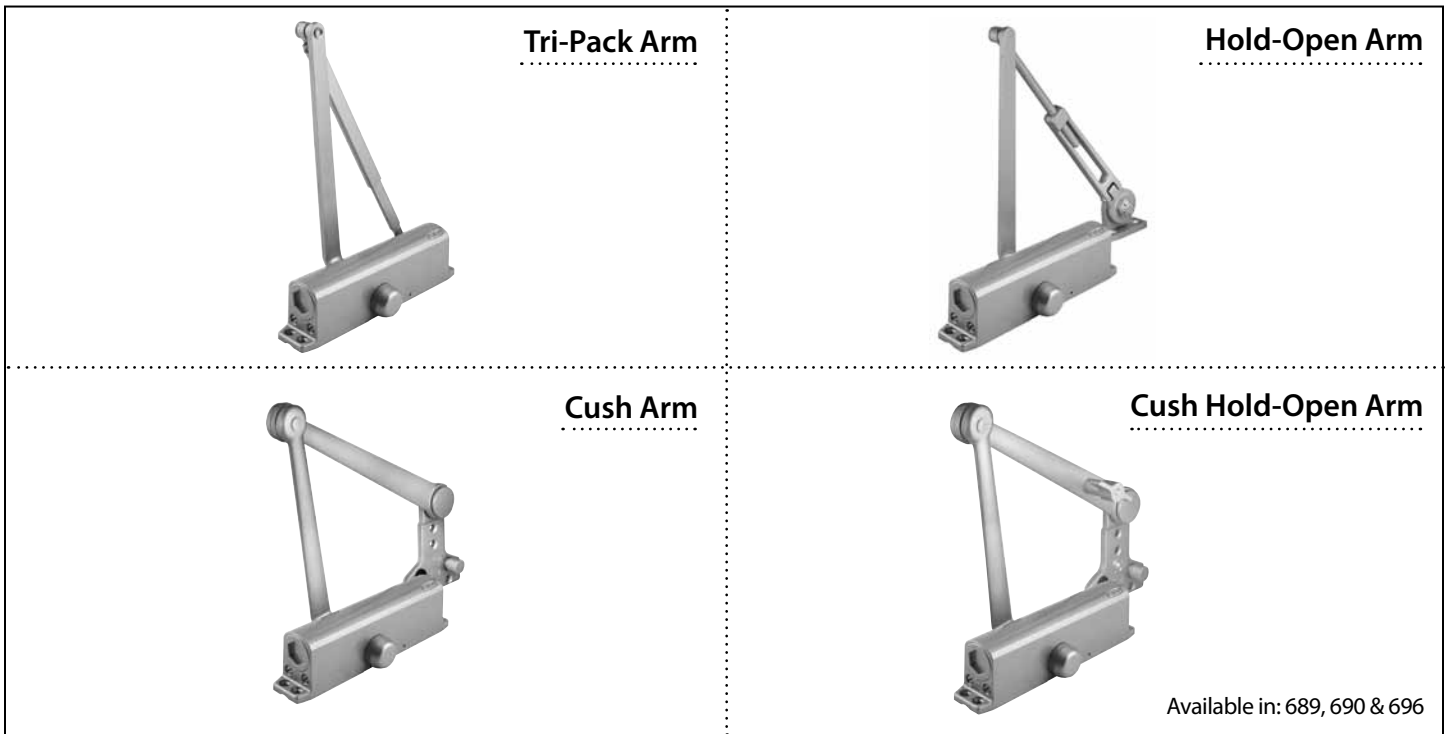

QDC300 series

Grade 1 Standard Duty Door Closers



Model/Series	Functions	List Price	Quantity
		689, 690 & 696	
QDC311	Tri-Packed Arm, Non-Hold Open	\$ 147.00	6
QDC312	Hold-Open Arm	\$ 177.00	6
QDC313	Dead Stop (Cush) Arm	\$ 233.00	3
QDC314	Dead Stop (Cush) Hold-Open Arm	\$ 249.00	3















Order with Closer	Description	With Closer	Service Part #	List Price
 F	Full Size Cover (Specify finish)	Add \$15.00	8Q00095	\$15.00
 SN	Sex Nuts (Qty 4) (Specify finish)	Add \$4.50	8Q00097	\$4.50
 SD	Self Drilling Screws (Qty 8)	Add \$10.00	8Q00436	\$10.00



QDC300 series

Grade 1 Standard Duty Door Closers

OTHER PARTS & SCREW PACKS (SPECIFY FINISH)

	Description	Service Part #	List Price	Qty
	QDC300 Series Plastic Installation Template	8Q00455	\$26.50	1
	Tri-Pack Arm (requires screw pack 8Q00100)	8Q00087	\$34.00	1
	Hold-Open Arm (requires screw pack 8Q00099)	8Q00088	\$66.50	1
	Dead Stop (Cush) Arm (requires screw pack 8Q00098)	8Q00089	\$77.00	1
	Dead Stop (Cush) Hold-Open Arm (requires screw pack 8Q00098)	8Q00090	\$87.50	1
	Pinion Cap - QDC300 Series	8Q00092	\$4.00	1
	Parallel Arm Bracket (requires screw pack 8Q00102)	8Q00093	\$6.50	1
	Screw Pack for QDC313 Dead Stop (Cush) Arm & QDC314 Dead Stop (Cush) Arm Hold-Open	8Q00098	\$1.75	1
	Screw Pack for QDC312 Hold-Open Arm	8Q00099	\$1.75	1
	Mounting Screw Pack for QDC300 Series	8Q00100	\$1.75	1
	Screw Pack for Parallel Arm Bracket	8Q00102	\$1.75	1
	Self drilling screw pack (Qty 8)	8Q00436	\$10.00	1
	Small Drop Plate Kit for QDC300 Series, Pull Only (2.38" x 9.76")	8Q00103	\$29.00	1
	Large Drop Plate Kit for QDC300 Series, Pull Only (3.27" x 9.76")	8Q00104	\$29.00	1



Weights and Measurements

Product	Function	Unit Weight	Case Qty	Pallet Qty	Case Box			Unit Box			Section
					Length	Width	Height	Length	Width	Height	
QMS/QME/QML SERIES - GRADE 1 MORTISE LOCKS											
Sectional Trims											
QMS120	Single Dummy Sectional	1.23	4	96	17	14.25	10	13.38	8.63	4	D
QMS122	Full Dummy Sectional	1.8	4	96	17	14.25	10	13.38	8.63	4	
QMS130	Passage Sectional	4.83	4	96	17	14.25	10	13.38	8.63	4	
QMS140	Privacy Sectional	5.75	4	96	17	14.25	10	13.38	8.63	4	
QMS145	Privacy w/ Deadbolt Sectional	6	4	96	17	14.25	10	13.38	8.63	4	
QMS150	Entry Sectional	5.85	4	96	17	14.25	10	13.38	8.63	4	
QMS152	Exit Sectional	6.50	4	96	17	14.25	10	13.38	8.63	4	
QMS154	Corridor Sectional	6.56	4	96	17	14.25	10	13.38	8.63	4	
QMS158	Dormitory Sectional	6.64	4	96	17	14.25	10	13.38	8.63	4	
QMS160	Classroom Sectional	5.79	4	96	17	14.25	10	13.38	8.63	4	
QMS162	Classroom Security Sectional	6.42	4	96	17	14.25	10	13.38	8.63	4	
QMS164	Apartment Sectional	6.42	4	96	17	14.25	10	13.38	8.63	4	
QMS170	Storeroom Sectional	5.61	4	96	17	14.25	10	13.38	8.63	4	
QMS172	Institutional Sectional	6.20	4	96	17	14.25	10	13.38	8.63	4	
QMS174	Store Door Sectional	6.53	4	96	17	14.25	10	13.38	8.63	4	
Escutcheon Trims											
QME120	Single Dummy Escutcheon	2.30	4	96	17	14.25	10	13.38	8.63	4	D
QME122	Full Dummy Escutcheon	3.80	4	96	17	14.25	10	13.38	8.63	4	
QME130	Passage Escutcheon	6.04	4	96	17	14.25	10	13.38	8.63	4	
QME140	Privacy Escutcheon	6.44	4	96	17	14.25	10	13.38	8.63	4	
QME145	Privacy w/ Deadbolt Escutcheon	6.68	4	96	17	14.25	10	13.38	8.63	4	
QME150	Entry Escutcheon	6.93	4	96	17	14.25	10	13.38	8.63	4	
QME152	Exit Escutcheon	7.45	4	96	17	14.25	10	13.38	8.63	4	
QME154	Corridor Escutcheon	7.51	4	96	17	14.25	10	13.38	8.63	4	
QME158	Dormitory Escutcheon	7.65	4	96	17	14.25	10	13.38	8.63	4	
QME160	Classroom Escutcheon	6.78	4	96	17	14.25	10	13.38	8.63	4	
QME162	Classroom Security Escutcheon	7.41	4	96	17	14.25	10	13.38	8.63	4	
QME164	Apartment Escutcheon	7.41	4	96	17	14.25	10	13.38	8.63	4	
QME170	Storeroom Escutcheon	6.58	4	96	17	14.25	10	13.38	8.63	4	
QME172	Institutional Escutcheon	7.18	4	96	17	14.25	10	13.38	8.63	4	
QME174	Store Door Escutcheon	7.52	4	96	17	14.25	10	13.38	8.63	4	
Deadlocks											
QML180	Single Cylinder Deadlock	2.68	10	300	20.87	13.39	7.09	10	5.9	2.36	D
QML182	Double Cylinder Deadlock	2.95	10	300	20.87	13.39	7.09	10	5.9	2.36	
QML184	Single Sided Deadlock	2.28	10	300	20.87	13.39	7.09	10	5.9	2.36	
QML186	Classroom Deadlock	2.68	10	300	20.87	13.39	7.09	10	5.9	2.36	



Weights and Measurements

Product	Function	Unit Weight	Case Qty	Pallet Qty	Case Box			Unit Box			Section
					Length	Width	Height	Length	Width	Height	
QCL100 SERIES - GRADE 1 CYLINDRICAL LOCKS											
QCL120	Dummy	1.55	12	432	14	11.75	7.5	6.75	3.75	3.25	E
QCL130	Passage	4.7	6	192	15.5	12.5	10.25	7.5	9.75	4	
QCL135	Communicating	4.8	6	192	15.5	12.5	10.25	7.5	9.75	4	
QCL140	Privacy	4.8	6	192	15.5	12.5	10.25	7.5	9.75	4	
QCL150	Entry	5	6	192	15.5	12.5	10.25	7.5	9.75	4	
QCL151	Entry SFIC	5	6	192	15.5	12.5	10.25	7.5	9.75	4	
QCL160	Classroom	5	6	192	15.5	12.5	10.25	7.5	9.75	4	
QCL161	Classroom SFIC	5	6	192	15.5	12.5	10.25	7.5	9.75	4	
QCL170	Storeroom	5	6	192	15.5	12.5	10.25	7.5	9.75	4	
QCL171	Storeroom SFIC	5	6	192	15.5	12.5	10.25	7.5	9.75	4	
QCL200 SERIES - GRADE 2 CYLINDRICAL LOCKS											
QCL220	Dummy	1.2	12	432	14	11.75	7.5	6.75	3.75	3.25	F
QCL230	Passage	4	6	192	15.5	12.5	10.25	7.5	9.75	4	
QCL235	Communicating	4	6	192	15.5	12.5	10.25	7.5	9.75	4	
QCL240	Privacy	4.75	6	192	15.5	12.5	10.25	7.5	9.75	4	
QCL250	Entry	4.5	6	192	15.5	12.5	10.25	7.5	9.75	4	
QCL251	Entry SFIC	4.5	6	192	15.5	12.5	10.25	7.5	9.75	4	
QCL260	Classroom	4.5	6	192	15.5	12.5	10.25	7.5	9.75	4	
QCL261	Classroom SFIC	4.5	6	192	15.5	12.5	10.25	7.5	9.75	4	
QCL270	Storeroom	4.5	6	192	15.5	12.5	10.25	7.5	9.75	4	
QCL271	Storeroom SFIC	4.5	6	192	15.5	12.5	10.25	7.5	9.75	4	
QCI200 SERIES - GRADE 2 INTERCONNECT LOCKS											
QCI230	Single Locking	5.5	6	192	15.5	12.25	10.63	9.63	7.5	4	G
QCI231	Single Locking SFIC	5.5	6	192	15.5	12.25	10.63	9.63	7.5	4	
QCI250	Double Locking	5.5	6	192	15.5	12.25	10.63	9.63	7.5	4	
QCI251	Double Locking SFIC	5.5	6	192	15.5	12.25	10.63	9.63	7.5	4	
QTL200 SERIES - GRADE 2 TUBULAR LOCKS											
QTL220	Dummy	1.2	12	432	13.75	12.5	7	6	3.75	3.25	H
QTL230	Passage	2.3	10	320	17	13.25	8.75	8	6	3.25	
QTL235	Communicating	2.5	10	320	17	13.25	8.75	8	6	3.25	
QTL240	Privacy	2.8	10	320	17	13.25	8.75	8	6	3.25	
QTL250	Entry	2.8	10	320	17	13.25	8.75	8	6	3.25	
QTL251	Entry SFIC	2.8	10	320	17	13.25	8.75	8	6	3.25	
QTL260	Classroom	2.8	10	320	17	13.25	8.75	8	6	3.25	
QTL261	Classroom SFIC	2.8	10	320	17	13.25	8.75	8	6	3.25	
QTL270	Storeroom	2.8	10	320	17	13.25	8.75	8	6	3.25	
QTL271	Storeroom SFIC	2.8	10	320	17	13.25	8.75	8	6	3.25	
QDB100 SERIES - GRADE 1 DEADBOLTS											
QDB180	Single Cylinder	2.5	12	384	15.75	13.5	6.5	3	4	5	I
QDB181	Single Cylinder SFIC	2.5	12	384	15.75	13.5	6.5	3	4	5	
QDB182	Double Cylinder	2.8	12	384	15.75	13.5	6.5	3	4	5	
QDB183	Double Cylinder SFIC	2.8	12	384	15.75	13.5	6.5	3	4	5	
QDB186	Classroom	2.5	12	384	15.75	13.5	6.5	3	4	5	
QDB187	Classroom SFIC	2.5	12	384	15.75	13.5	6.5	3	4	5	



Product	Function	Unit Weight	Case Qty	Pallet Qty	Case Box			Unit Box			Section
					Length	Width	Height	Length	Width	Height	
QDB200 SERIES - GRADE 2 DEADBOLTS											
QDB280	Single Cylinder	2.3	12	384	15.75	13.5	6.5	3	4	5	J
QDB281	Single Cylinder SFIC	2.3	12	384	15.75	13.5	6.5	3	4	5	
QDB282	Double Cylinder	2.7	12	384	15.75	13.5	6.5	3	4	5	
QDB283	Double Cylinder SFIC	2.7	12	384	15.75	13.5	6.5	3	4	5	
QDB284	Inside Turnbolt	2	12	384	15.75	13.5	6.5	3	4	5	
QDB285	Indicator	1.27	12	384	15.75	13.5	6.5	3	4	5	
QDB286	Classroom	2.3	12	384	15.75	13.5	6.5	3	4	5	
QDB287	Classroom SFIC	2.3	12	384	15.75	13.5	6.5	3	4	5	
QDB288	Key Control	2.25	12	384	15.75	13.5	6.5	3	4	5	
QED100 SERIES - GRADE 1 HEAVY DUTY EXIT DEVICES & TRIMS											
QED111 36"	Rim Exit Only	11.7	1	40	36	10.25	5	36	10.25	5	K
QED112 36"	Rim Cylinder Dogging	11.7	1	40	36	10.25	5	36	10.25	5	
QED113 36"	Rim Fire Rated	11.5	1	40	36	10.25	5	36	10.25	5	
QED114 36" 7'	Surface Vertical Rod - Exit Only	14.7	1	40	36	10.25	5	36	10.25	5	
QED114 36" 8'	Surface Vertical Rod - Exit Only	14.9	1	40	48	10.25	5	48	10.25	5	
QED115 36" 7'	Surface Vertical Rod - Cylinder Dogging	14.7	1	40	36	10.25	5	36	10.25	5	
QED115 36" 8'	Surface Vertical Rod - Cylinder Dogging	14.9	1	40	48	10.25	5	48	10.25	5	
QED116 36" 7'	Surface Vertical Rod - Fire Rated	14.5	1	40	36	10.25	5	36	10.25	5	
QED116 36" 8'	Surface Vertical Rod - Fire Rated	14.7	1	40	48	10.25	5	48	10.25	5	
QED117 36" 7'	SVR - Less Bottom Rod - Exit Only	14.2	1	40	36	10.25	5	36	10.25	5	
QED117 36" 8'	SVR - Less Bottom Rod - Exit Only	14.4	1	40	48	10.25	5	48	10.25	5	
QED118 36" 7'	SVR - Less Bottom Rod - Cylinder Dogging	14.2	1	40	36	10.25	5	36	10.25	5	
QED118 36" 8'	SVR - Less Bottom Rod - Cylinder Dogging	14.4	1	40	48	10.25	5	48	10.25	5	
QED119 36" 7'	SVR - Less Bottom Rod - Fire Rated	14.7	1	40	36	10.25	5	36	10.25	5	
QED119 36" 8'	SVR - Less Bottom Rod - Fire Rated	14.9	1	40	48	10.25	5	48	10.25	5	
QED124 36" 7'	Concealed Vertical Rod - Exit Only	14.7	1	40	36	10.25	5	36	10.25	5	
QED124 36" 8'	Concealed Vertical Rod - Exit Only	14.9	1	40	48	10.25	5	48	10.25	5	
QED125 36" 7'	Concealed Vertical Rod - Cylinder Dogging	14.7	1	40	36	10.25	5	36	10.25	5	
QED125 36" 8'	Concealed Vertical Rod - Cylinder Dogging	14.9	1	40	48	10.25	5	48	10.25	5	
QED126 36" 7'	Concealed Vertical Rod - Fire Rated	14.5	1	40	36	10.25	5	36	10.25	5	
QED126 36" 8'	Concealed Vertical Rod - Fire Rated	14.7	1	40	48	10.25	5	48	10.25	5	
QED127 36" 7'	CVR - Less Bottom Rod - Exit Only	14.2	1	40	36	10.25	5	36	10.25	5	
QED127 36" 8'	CVR - Less Bottom Rod - Exit Only	14.4	1	40	48	10.25	5	48	10.25	5	
QED128 36" 7'	CVR - Less Bottom Rod - Cylinder Dogging	14.2	1	40	36	10.25	5	36	10.25	5	
QED128 36" 8'	CVR - Less Bottom Rod - Cylinder Dogging	14.4	1	40	48	10.25	5	48	10.25	5	
QED129 36" 7'	CVR - Less Bottom Rod - Fire Rated	14.7	1	40	36	10.25	5	36	10.25	5	
QED129 36" 8'	CVR - Less Bottom Rod - Fire Rated	14.9	1	40	48	10.25	5	48	10.25	5	
QED111 48"	Rim Exit Only	11.9	1	40	48	10.25	5	48	10.25	5	
QED112 48"	Rim Cylinder Dogging	11.9	1	40	48	10.25	5	48	10.25	5	
QED113 48"	Rim Fire Rated	11.7	1	40	48	10.25	5	48	10.25	5	
QED114 48" 7'	Surface Vertical Rod - Exit Only	14.9	1	40	48	10.25	5	48	10.25	5	
QED114 48" 8'	Surface Vertical Rod - Exit Only	15.1	1	40	48	10.25	5	48	10.25	5	
QED115 48" 7'	Surface Vertical Rod - Cylinder Dogging	14.9	1	40	48	10.25	5	48	10.25	5	
QED115 48" 8'	Surface Vertical Rod - Cylinder Dogging	15.1	1	40	48	10.25	5	48	10.25	5	



Product	Function	Unit Weight	Case Qty	Pallet Qty	Case Box			Unit Box			Section
					Length	Width	Height	Length	Width	Height	
QED116 48" 7'	Surface Vertical Rod - Fire Rated	14.7	1	40	48	10.25	5	48	10.25	5	K
QED116 48" 8'	Surface Vertical Rod - Fire Rated	14.9	1	40	48	10.25	5	48	10.25	5	
QED117 48" 7'	SVR - Less Bottom Rod - Exit Only	14.4	1	40	48	10.25	5	48	10.25	5	
QED117 48" 8'	SVR - Less Bottom Rod - Exit Only	14.6	1	40	48	10.25	5	48	10.25	5	
QED118 48" 7'	SVR - Less Bottom Rod - Cylinder Dogging	14.4	1	40	48	10.25	5	48	10.25	5	
QED118 48" 8'	SVR - Less Bottom Rod - Cylinder Dogging	14.6	1	40	48	10.25	5	48	10.25	5	
QED119 48" 7'	SVR - Less Bottom Rod - Fire Rated	14.9	1	40	48	10.25	5	48	10.25	5	
QED119 48" 8'	SVR - Less Bottom Rod - Fire Rated	15.1	1	40	48	10.25	5	48	10.25	5	
QED124 48" 7'	Concealed Vertical Rod - Exit Only	14.9	1	40	48	10.25	5	48	10.25	5	
QED124 48" 8'	Concealed Vertical Rod - Exit Only	15.1	1	40	48	10.25	5	48	10.25	5	
QED125 48" 7'	Concealed Vertical Rod - Cylinder Dogging	14.9	1	40	48	10.25	5	48	10.25	5	
QED125 48" 8'	Concealed Vertical Rod - Cylinder Dogging	15.1	1	40	48	10.25	5	48	10.25	5	
QED126 48" 7'	Concealed Vertical Rod - Fire Rated	14.7	1	40	48	10.25	5	48	10.25	5	
QED126 48" 8'	Concealed Vertical Rod - Fire Rated	14.9	1	40	48	10.25	5	48	10.25	5	
QED127 48" 7'	CVR - Less Bottom Rod - Exit Only	14.4	1	40	48	10.25	5	48	10.25	5	
QED127 48" 8'	CVR - Less Bottom Rod - Exit Only	14.6	1	40	48	10.25	5	48	10.25	5	
QED128 48" 7'	CVR - Less Bottom Rod - Cylinder Dogging	14.4	1	40	48	10.25	5	48	10.25	5	
QED128 48" 8'	CVR - Less Bottom Rod - Cylinder Dogging	14.4	1	40	48	10.25	5	48	10.25	5	
QED129 48" 7'	CVR - Less Bottom Rod - Fire Rated	14.9	1	40	48	10.25	5	48	10.25	5	
QED129 48" 8'	CVR - Less Bottom Rod - Fire Rated	15.1	1	40	48	10.25	5	48	10.25	5	
QET100 Series - Heavy Duty Escutcheon Exit Trim											
QET120	Dummy Escutcheon Lever	2.2	6	288	16.81	14.25	9.13	8.27	5.34	3.34	K
QET125	Dummy Escutcheon Pull	1.9	6	162	14.9	10.35	8.7	14.37	3.15	3.86	
QET130	Passage Escutcheon Lever	2.2	6	288	16.81	14.25	9.13	8.27	5.34	3.34	
QET160	Keyed Escutcheon Lever (Classroom)	2.9	6	288	16.81	14.25	9.13	8.27	5.34	3.34	
QET165	Thumbpiece Escutcheon Pull	3.1	6	162	14.9	10.35	8.7	14.37	3.15	3.86	
QET167	Thumbpiece Dummy Escutcheon Pull	1.9	6	162	14.9	10.35	8.7	14.37	3.15	3.86	
QET170	Night Latch Escutcheon Lever (Storeroom)	2.8	6	288	16.81	14.25	9.13	8.27	5.34	3.34	
QET175	Night Latch Pull (Storeroom)	1.9	6	162	14.9	10.35	8.7	14.37	3.15	3.86	
QET190	Flat/Blank Escutcheon Plate	1.4	6	162	14.9	10.35	8.7	14.37	3.15	3.86	
QED300 SERIES - GRADE 1 STANDARD DUTY EXIT DEVICES & TRIMS											
QED311 36"	Rim Exit Only	6.2	4	48	36.5	16	8.2	36.5	7.25	3.75	L
QED312 36"	Rim Cylinder Dogging	6.2	4	48	36.5	16	8.2	36.5	7.25	3.75	
QED313 36"	Rim Fire Rated	6	4	48	36.5	16	8.2	36.5	7.25	3.75	
QED314 36" 7'	Surface Vertical Rod - Exit Only	8.2	4	48	36.5	16	8.2	36.5	7.25	3.75	
QED314 36" 8'	Surface Vertical Rod - Exit Only	8.4	4	48	36.5	16	8.2	36.5	7.25	3.75	
QED315 36" 7'	Surface Vertical Rod - Cylinder Dogging	8.2	4	48	36.5	16	8.2	36.5	7.25	3.75	
QED315 36" 8'	Surface Vertical Rod - Cylinder Dogging	8.4	4	48	36.5	16	8.2	36.5	7.25	3.75	
QED316 36" 7'	Surface Vertical Rod - Fire Rated	8	4	48	36.5	16	8.2	36.5	7.25	3.75	
QED316 36" 8'	Surface Vertical Rod - Fire Rated	8.2	4	48	36.5	16	8.2	36.5	7.25	3.75	
QED317 36" 7'	SVR - Less Bottom Rod - Exit Only	8	4	48	36.5	16	8.2	36.5	7.25	3.75	
QED317 36" 8'	SVR - Less Bottom Rod - Exit Only	8.2	4	48	36.5	16	8.2	36.5	7.25	3.75	
QED318 36" 7'	SVR - Less Bottom Rod - Cylinder Dogging	8	4	48	36.5	16	8.2	36.5	7.25	3.75	
QED318 36" 8'	SVR - Less Bottom Rod - Cylinder Dogging	8.2	4	48	36.5	16	8.2	36.5	7.25	3.75	
QED319 36" 7'	SVR - Less Bottom Rod - Fire Rated	8.2	4	48	36.5	16	8.2	36.5	7.25	3.75	



Product	Function	Unit Weight	Case Qty	Pallet Qty	Case Box			Unit Box			Section
					Length	Width	Height	Length	Width	Height	
QED319 36" 8'	SVR - Less Bottom Rod - Fire Rated	8.4	4	48	36.5	16	8.2	36.5	7.25	3.75	L
QED311 48"	Rim Exit Only	6.4	4	48	48.5	16	8.2	48.5	7.25	3.75	
QED312 48"	Rim Cylinder Dogging	6.4	4	48	48.5	16	8.2	48.5	7.25	3.75	
QED313 48"	Rim Fire Rated	6.2	4	48	48.5	16	8.2	48.5	7.25	3.75	
QED314 48" 7"	Surface Vertical Rod - Exit Only	8.4	4	48	48.5	16	8.2	48.5	7.25	3.75	
QED314 48" 8'	Surface Vertical Rod - Exit Only	8.6	4	48	48.5	16	8.2	48.5	7.25	3.75	
QED315 48" 7"	Surface Vertical Rod - Cylinder Dogging	8.4	4	48	48.5	16	8.2	48.5	7.25	3.75	
QED315 48" 8'	Surface Vertical Rod - Cylinder Dogging	8.6	4	48	48.5	16	8.2	48.5	7.25	3.75	
QED316 48" 7"	Surface Vertical Rod - Fire Rated	8.2	4	48	48.5	16	8.2	48.5	7.25	3.75	
QED316 48" 8'	Surface Vertical Rod - Fire Rated	8.4	4	48	48.5	16	8.2	48.5	7.25	3.75	
QED317 48" 7"	SVR - Less Bottom Rod - Exit Only	8.2	4	48	48.5	16	8.2	48.5	7.25	3.75	
QED317 48" 8'	SVR - Less Bottom Rod - Exit Only	8.4	4	48	48.5	16	8.2	48.5	7.25	3.75	
QED318 48" 7"	SVR - Less Bottom Rod - Cylinder Dogging	8.2	4	48	48.5	16	8.2	48.5	7.25	3.75	
QED318 48" 8'	SVR - Less Bottom Rod - Cylinder Dogging	8.4	4	48	48.5	16	8.2	48.5	7.25	3.75	
QED319 48" 7"	SVR - Less Bottom Rod - Fire Rated	8.4	4	48	48.5	16	8.2	48.5	7.25	3.75	
QED319 48" 8'	SVR - Less Bottom Rod - Fire Rated	8.6	4	48	48.5	16	8.2	48.5	7.25	3.75	
QET300 Series - Standard Duty Escutcheon Exit Trim											
QET320	Dummy Escutcheon Lever	2.25	12	324	16.81	14.25	9.13	8.27	5.34	3.34	L
QET325	Dummy Escutcheon Pull	1.9	6	162	14.9	10.35	8.7	14.37	3.15	3.86	
QET330	Passage Escutcheon Lever	2.8	12	324	16.81	14.25	9.13	8.27	5.34	3.34	
QET360	Keyed Escutcheon Lever (Classroom)	2.8	12	324	16.81	14.25	9.13	8.27	5.34	3.34	
QET365	Thumbpiece Escutcheon Pull	3.1	6	162	14.9	10.35	8.7	14.37	3.15	3.86	
QET367	Thumbpiece Dummy Escutcheon Pull	1.9	6	162	14.9	10.35	8.7	14.37	3.15	3.86	
QET370	Night Latch Escutcheon Lever (Storeroom)	2.8	12	324	16.81	14.25	9.13	8.27	5.34	3.34	
QET375	Night Latch Pull (Storeroom)	1.9	6	162	14.9	10.35	8.7	14.37	3.15	3.86	
QET377	Gull Wing Trim (Storeroom)	1.7	12	324	16.81	14.25	9.13	8.27	5.34	3.34	
QET390	Flat/Blank Escutcheon Plate	1.4	6	162	14.9	10.35	8.7	14.37	3.15	3.86	
QRT300 Series - Standard Duty Round Rose Trim											
QRT320	Dummy Round Rose	2.07	12	432	14	11.75	7.5	7.5	6.75	3.75	L
QRT330	Passage Round Rose	2.07	12	432	14	11.75	7.5	7.5	6.75	3.75	
QRT360	Entry Round Rose (Classroom)	2.8	12	432	14	11.75	7.5	7.5	6.75	3.75	
QRT361	Entry Round Rose SFIC (Classroom)	2.8	12	432	14	11.75	7.5	7.5	6.75	3.75	
QRT370	Night Latch Round Rose (Storeroom)	2.8	12	432	14	11.75	7.5	7.5	6.75	3.75	
QRT371	Night Latch Round Rose SFIC (Storeroom)	2.8	12	432	14	11.75	7.5	7.5	6.75	3.75	
DOOR CLOSERS											
Extra Heavy Duty											
QDC111	Tri-pack non-hold open	12.3	3	126	14.25	16.5	6	14.25	5.5	6	M
QDC112	Hold Open	13.3	1	138	14.25	5.5	7	14.25	5.5	7	
QDC113	Dead stop (cush) arm	14	1	138	14.25	5.5	7	14.25	5.5	7	
QDC114	Dead stop (cush) hold open	14	1	115	14.25	5.5	8	14.25	5.5	8	
QDC115	Extra duty (EDA)	13.6	1	138	14.25	5.5	7	14.25	5.5	7	
QDC116	Extra duty hold open (HEDA)	13.8	1	138	14.25	5.5	7	14.25	5.5	7	
Heavy Duty											
QDC211	Tri-pack non-hold open	6.6	6	180	14.25	15.75	7.5	13.5	4.875	3.25	N
QDC212	Hold Open	8	6	180	14.25	15.75	7.5	13.5	4.875	3.25	
QDC213	Dead stop (cush) arm	8.5	3	216	14.25	15.75	7.5	13.375	7.875	3.25	
QDC214	Dead stop (cush) hold open	8.7	3	216	14.25	15.75	7.5	13.375	7.875	3.25	
Standard Duty											
QDC311	Tri-pack non-hold open	6.3	6	180	14.25	15.75	7.5	13.5	4.875	3.25	O
QDC312	Hold Open	7.7	6	180	14.25	15.75	7.5	13.5	4.875	3.25	
QDC313	Dead stop (cush) arm	8.2	3	216	14.25	15.75	7.5	13.375	7.875	3.25	
QDC314	Dead stop (cush) hold open	8.4	3	216	14.25	15.75	7.5	13.375	7.875	3.25	



19701 DaVinci, Lake Forest, CA 92610
www.K2commercialhardware.com



Stanley Security Solutions, Inc.
6161 East 75th St, Indianapolis, Indiana 46250

© 2011 Stanley Security Solutions, Inc. • www.stanleysecuritysolutions.com

10M 0411FP
K2010